

ASMAX F1 Pro Max

**Bluetooth Voice-Controlled Headset with
Mesh Intercom System**

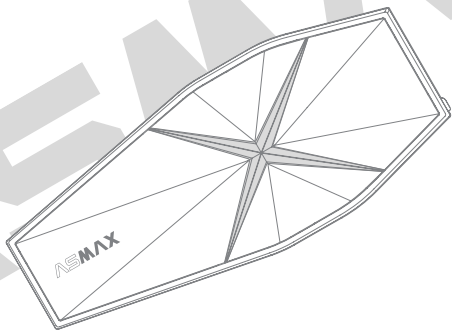

QUICK START GUIDE

Profile

Thank you for choosing the ASMAX voice-controlled Bluetooth helmet intercom. Please read this guide carefully before using the device.



**For detailed electronic instructions,
please scan the QR code.**



**Youtube
Video Instruction**



**Firmware Update
Instruction Video**

ASMAX WORLD APP

You can configure more features on your ASMAX device through the ASMAX WORLD app. Scan the QR code or download it from the Google Play Store or Apple App Store.



ASMAX WORLD
App



Download on the
App Store



GET IT ON
Google Play



Web: www.asmaxconnect.com

Package Contents

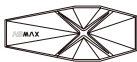

F1 Pro Max
Main Unit



Mounting Base

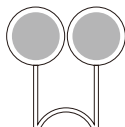

Speaker Unit



3M Glue Plate



Metal Clamp



Hybrid
Microphone



Wired
Microphone



Type-C Cable



Clean Pack

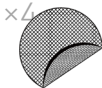

Speaker Pads

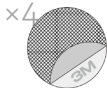

Velcro for
Speaker



Velcro for
Wired Mic



Velcro for
Hybrid Mic



Microphone
Sponge









Spare 3M

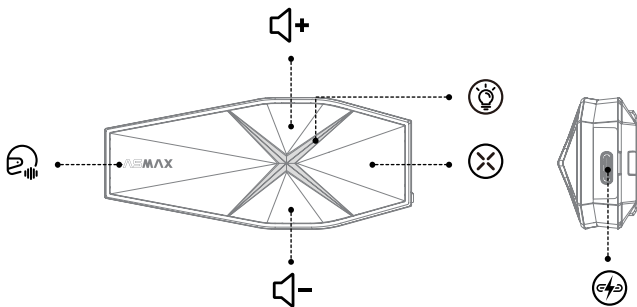

User Manual

Main Unit



	Volume +
	Volume -
	Intercom Button
	Function Button
	LED Indicator
	Type-C Charging Port

Note:

- The headset can fully charge within 50mins (The Charging time maybe changed due to charging environment)
- Do not use a charger with an output more than 15V to charge the device.

Quick Operation

ASMAX has two operation modes: Smart Voice and Button Control. You can choose the one that suits your habits.

When connected to the ASMAX World App and the internet, the main unit supports smart voice operations such as navigation, sending messages, making and receiving calls, and playing music.

When not connected to the internet, the main unit can still control the device using built-in local voice commands.

Function	Wakeword	MAX Answer	Offline Commands (If the main unit or phone is offline, MAX can only use offline commands.)
Power On/Off	/	/	
For Music Control	Hi Max	OK/Here/ Coming	Music On
	Hi Max		Pause Music
For Playback Control	Hi Max		Previous Track
	Hi Max		Next Track
For Volume Control	Hi Max		Volume Up
	Hi Max		Volume Down
For Phone Control	Hi Max		Answer The Phone
	Hi Max		Hang Up
For Phone Pairing	Hi Max		Phone Pairing
For Intercom	Hi Max		Group Mesh
	Hi Max		Free Mode
	Hi Max		Group Mode
	Hi Max		End Intercom

Function	Wakeword	MAX Answer	Offline Commands (If the main unit or phone is offline, MAX can only use offline commands.)
For Radio	Hi Max	OK/Here/ Coming	Radio On
	Hi Max		Turn Off The Radio
	Hi Max		Previous Station
	Hi Max		Next Station
For ASMAX Mode	Hi Max		Group MAX
	Hi Max		MAX Mode
For Microphone Control	Hi Max		Unmute Microphone
	Hi Max		Mute Microphone
Place on mount → Power On Remove from mount → Power Off			This feature must be enabled in the app.

Online Commands

(If MAX is paired with a phone and the phone is online, just say “Hi MAX” to control any commands supported by Siri or Google Assistant.)

What's the weather like today

Set an alarm at nine o'clock

Turn on music player

Turn on Asmax World APP

Navigate to my home

Call Berry

Other commands of Siri/ Google Assistant that support

Profil

Vielen Dank, dass Sie sich für das ASMAX Bluetooth Helm Intercom mit Sprachsteuerung entschieden haben. Bitte lesen Sie diese Anleitung vor der Verwendung des Geräts sorgfältig durch.



**Für detaillierte elektronische Anweisungen
scannen Sie bitte den QR-Code.**



**Youtube
Video Anleitung**



**Firmware Update
Anleitungsvideo**

ASMAX WORLD APP

Sie können weitere Funktionen Ihres ASMAX-Geräts über die ASMAX WORLD App konfigurieren. Scannen Sie den QR-Code oder laden Sie die App aus dem Google Play Store oder Apple App Store herunter.



ASMAX WORLD
App



Download on the
App Store



GET IT ON
Google Play



Web: www.asmaxconnect.com

Lieferumfang

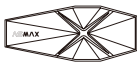

F1 Pro Max
Hauptgerät



Montagebasis

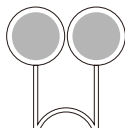

Lautsprechereinheit



3M Klebeplatte



Metallklemme



Schwanenhals-
mikrofon



Kabelgebundenes
Mikrofon



Type-C Kabel



Reinigungspack

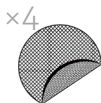

Lautsprecher-
polster

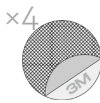

Klettverschluss
für Lautsprecher



Klettverschluss für
kabelgebundenes
Mikrofon



Klettverschluss für
Schwanenhalsmikrofon



Mikrofon Schwamm



Ersatz 3M



Benutzerhandbuch

Hauptgerät

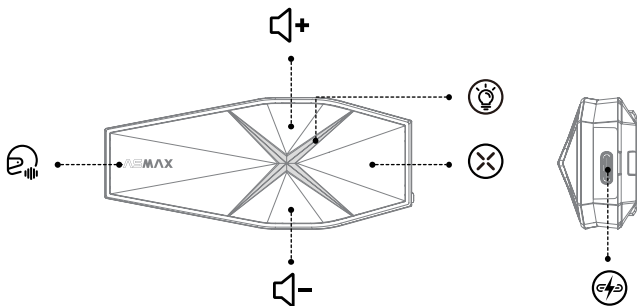

	Lautstärke +
	Lautstärke -
	Intercom Taste
	Funktions Taste
	LED Anzeige
	Type-C Ladeanschluss

Hinweis:



- Das Headset kann in ca. 50 Minuten vollständig aufgeladen werden (die Ladezeit kann je nach Ladeumgebung variieren).
- Verwenden Sie keinen Ladeadapter mit einer Ausgangsspannung von mehr als 15 V, um das Gerät aufzuladen.

Schnellbedienung

ASMAX verfügt über zwei Betriebsmodi: Sprachsteuerung und Tastensteuerung. Sie können den Modus wählen, der am besten zu Ihren Gewohnheiten passt.

Wenn die Hauptgeräteeinheit mit der ASMAX World App und dem Internet verbunden ist, unterstützt sie smarte Sprachfunktionen wie Navigation, Nachrichten senden, Anrufe tätigen und empfangen sowie Musikwiedergabe.

Wenn keine Internetverbindung besteht, kann die Hauptgeräteeinheit das Gerät weiterhin über die eingebauten Sprachbefehle steuern.

Funktion	Weckwort	MAX Antwort	Offline-Befehle (Wenn die Hauptgeräteeinheit oder das Telefon offline ist, kann MAX nur Offline-Befehle verwenden.)
Für Ein/Aus	/	/	   2s
Für Musiksteuerung	Hi Max	Ja, bitte/ Bin da/Hier	Music On
	Hi Max		Pause Music
Für Wieder-gabe	Hi Max		Previous Track
	Hi Max		Next Track
Für Lautstärke-regelung	Hi Max		Volume Up
	Hi Max		Volume Down
Für Telefonsteuerung	Hi Max		Answer The Phone
	Hi Max		Hang Up
Für Telefonkopplung	Hi Max		Phone Pairing
Für Intercom	Hi Max		Group Mesh
	Hi Max		Free Mode
	Hi Max		Group Mode
	Hi Max		End Intercom

Funktion	Weckwort	MAX Antwort	Offline-Befehle (Wenn die Hauptgeräteeinheit oder das Telefon offline ist, kann MAX nur Offline-Befehle verwenden.)
Für Radio	Hi Max	Ja,bitte/ Bin da/Hier	Radio On
	Hi Max		Turn Off The Radio
	Hi Max		Previous Station
	Hi Max		Next Station
Für intelligente Netzwerk-konfiguration	Hi Max		Group MAX
	Hi Max		MAX Mode
Für Mikrofon-steuerung	Hi Max		Unmute Microphone
	Hi Max		Mute Microphone
Automatisches Einschalten durch magnetische Saugkraft, automatisches Ausschalten durch Entfernen vom Sockel			Der Kontrollschalter muss in der App-Oberfläche aktiviert werden

Online-Befehle

(Wenn MAX mit einem Telefon gekoppelt ist und das Telefon online ist, sagen Sie einfach „Hi MAX“, um alle Befehle zu steuern, die von Siri oder Google Assistant unterstützt werden.)

Wie ist das Wetter heute?

Stelle einen Wecker auf neun Uhr.

Musikplayer einschalten

ASMAX World App starten

Navigiere zu meinem Zuhause

Rufe Berry an

Weitere von Siri/Google Assistant unterstützte Befehle

Profilo

Grazie per aver scelto l'interfono Bluetooth per casco ASMAX con controllo vocale. Si prega di leggere attentamente questa guida prima di utilizzare il dispositivo.



**Per consultare le istruzioni elettroniche dettagliate,
scansionare il codice QR.**



**Video Tutorial su
YouTube**



**Video Istruzioni
Aggiornamento Firmware**

ASMAX WORLD APP

È possibile configurare ulteriori funzioni sul dispositivo ASMAX tramite l'app ASMAX WORLD. Scansionare il codice QR o scaricarla da Google Play Store o Apple App Store.



ASMAX WORLD
App



Download on the
App Store



GET IT ON
Google Play



Web: www.asmaxconnect.com

Contenuto della Confezione



Unità principale
F1 Pro Max



Base di montaggio

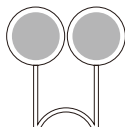

Unità altoparlante



Piastra adesiva 3M



Morsetto in
metallo



Microfono con
braccio flessibile



Microfono cablato



Cavo Type-C



Kit di pulizia

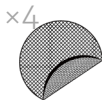

Pad per
altoparlante



Velcro per
altoparlante



Velcro per
microfono cablato



Velcro per
microfono ibrido



Spugna per
microfono





3M di
ricambio

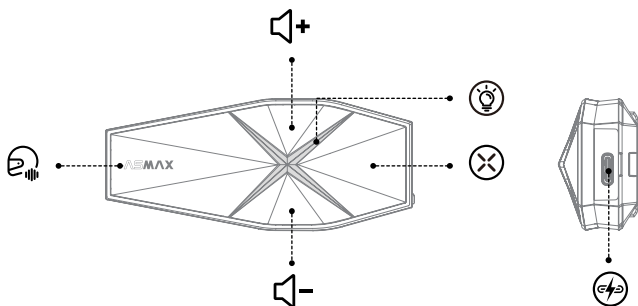

Manuale utente

Unità principale



	Volume +
	Volume -
	Pulsante interfono
	Pulsante funzione
	Indicatore LED
	Porta di ricarica Type-C

Nota:

- Gli interfono possono caricarsi completamente in 50 minuti (il tempo di ricarica può variare a seconda dell'ambiente di carica).
- Non utilizzare un caricatore con uscita superiore a 15V per caricare il dispositivo.

Operazione rapida

ASMAX ha due modalità operative: Voce intelligente e Controllo tramite pulsante. Puoi scegliere quella più adatta alle tue abitudini. Quando è connessa all'App ASMAX World e a Internet, l'unità principale supporta operazioni vocali intelligenti come navigazione, invio di messaggi, chiamate e riproduzione musicale. Quando non è connessa a Internet, l'unità principale può comunque controllare il dispositivo tramite comandi vocali locali integrati.

Funzione	Parola di attivazione	Risposta di MAX	Comandi offline (Se l'unità principale o il telefono sono offline, MAX può usare solo comandi offline.)
Accensione/Spegnimento	/	/	 +    2s
Per il controllo della musica	Hi Max	Eccolo qui/Ecco qua/Vai avanti	Music On
	Hi Max		Pause Music
Per il controllo della riproduzione	Hi Max		Previous Track
	Hi Max		Next Track
Per il controllo del volume	Hi Max		Volume Up
	Hi Max		Volume Down
Per il controllo del telefono	Hi Max		Answer The Phone
	Hi Max		Hang Up
Associare interfono Bluetooth di altre marche	Hi Max		Phone Pairing
Per l'interfono	Hi Max		Group Mesh
	Hi Max		Free Mode
	Hi Max		Group Mode
	Hi Max	End Intercom	

Funzione	Parola di attivazione	Risposta di MAX	Comandi offline (Se l'unità principale o il telefono sono offline, MAX può usare solo comandi offline.)
Per la radio	Hi Max	Eccolo qui/Ecco qua/Vai avanti	Radio On
	Hi Max		Turn Off The Radio
	Hi Max		Previous Station
	Hi Max		Next Station
Configurazione rete intelligente	Hi Max		Group MAX
	Hi Max		MAX Mode
Microfono on/off	Hi Max		Unmute Microphone
	Hi Max		Mute Microphone
Si accende automaticamente quando è collegato alla base magnetica.			Abilita l'interruttore di controllo nell'app.

Comandi online (Se MAX è abbinato a un telefono e il telefono è online, basta dire “Hi MAX” per controllare tutti i comandi supportati da Siri o Google Assistant.)

Com'è il tempo oggi?

Imposta una sveglia alle nove

Accendi il lettore musicale

Apri l'APP Asmax World

Naviga a casa mia

Chiama Berry

Altri comandi supportati da Siri/Google Assistant

Profil

Merci d'avoir choisi l'intercom Bluetooth pour casque ASMAX avec commande vocale. Veuillez lire attentivement ce guide avant d'utiliser l'appareil.



**Pour consulter les instructions électroniques détaillées,
veuillez scanner le code QR.**



**Vidéo Tutoriel sur
YouTube**



**Vidéo d'Instruction pour la
Mise à Jour du Firmware**

ASMAX WORLD APP

Vous pouvez configurer davantage de fonctionnalités sur votre appareil ASMAX via l'application ASMAX WORLD. Scannez le code QR ou téléchargez-la depuis Google Play Store ou Apple App Store.



ASMAX WORLD
App



Download on the
App Store



GET IT ON
Google Play



Web: www.asmaxconnect.com

Contenu du Colis



Unité principale
F1 Pro Max

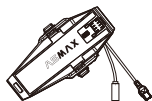

Base de
fixation

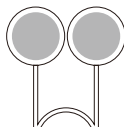

Unité de
haut-parleur



Plaque
adhésive 3M



Clamp en
métal



Microphone
avec bras flexible



Microphone
filaire



Câble Type-C



Pack de
nettoyage

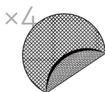

Tampons pour
haut-parleur



Velcro pour
haut-parleur



Velcro pour
microphone filaire



Velcro pour
microphone hybride



Éponge pour
microphone



3M de
rechange



Manuel
d'utilisateur

Unité principale

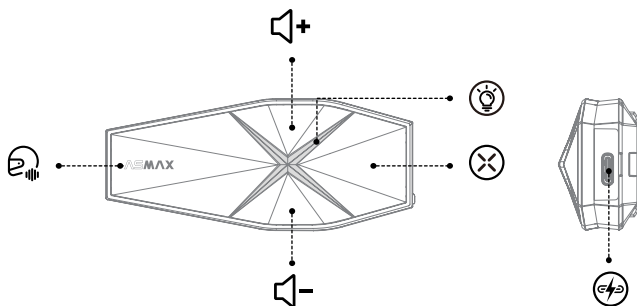





	Volume +
	Volume -
	Bouton intercom
	Bouton fonction
	Indicateur LED
	Port de charge Type-C

Remarque :

- Les interphones peuvent se charger complètement en 50 minutes (le temps de charge peut varier selon l'environnement de charge).
- N'utilisez pas un chargeur avec une sortie supérieure à 15V pour charger l'appareil.

Fonctionnement rapide

ASMAX dispose de deux modes de fonctionnement : Voix intelligente et Contrôle par bouton. Vous pouvez choisir celui qui convient à vos habitudes. Lorsqu'elle est connectée à l'application ASMAX World et à Internet, l'unité principale prend en charge les commandes vocales intelligentes telles que la navigation, l'envoi de messages, les appels et la lecture de musique. Lorsqu'elle n'est pas connectée à Internet, l'unité principale peut toujours contrôler l'appareil via des commandes vocales locales intégrées.

Fonction	Mot d'activation	Réponse de MAX	Commandes hors ligne (Si l'unité principale ou le téléphone est hors ligne, MAX ne peut utiliser que les commandes hors ligne.)
Allumer/ Éteindre	/	/	 +    2s
Pour le contrôle de la musique	Hi Max	Je suis ici/Je viens ici/Allez-y	Music On
	Hi Max		Pause Music
Pour le contrôle de la lecture	Hi Max		Previous Track
	Hi Max		Next Track
Pour le contrôle du volume	Hi Max		Volume Up
	Hi Max		Volume Down
Pour le contrôle du téléphone	Hi Max		Answer The Phone
	Hi Max		Hang Up
Appairer des intercoms Bluetooth d'autres marques	Hi Max		Phone Pairing
Pour l'interphone	Hi Max		Group Mesh
	Hi Max	Free Mode	
	Hi Max	Group Mode	
	Hi Max	End Intercom	

Fonction	Mot d'activation	Réponse de MAX	Commandes hors ligne (Si l'unité principale ou le téléphone est hors ligne, MAX ne peut utiliser que les commandes hors ligne.)	
Pour la radio	Hi Max	Je suis ici/Je viens ici/Allez-y	Radio On	
	Hi Max		Turn Off The Radio	
	Hi Max		Previous Station	
	Hi Max		Next Station	
Configuration réseau intelligent	Hi Max		Group MAX	
	Hi Max		MAX Mode	
Microphone on/off	Hi Max		Unmute Microphone	
	Hi Max		Mute Microphone	
Mise en marche automatique magnétique, arrêt automatique lorsque l'on quitte la base			L'interrupteur de contrôle doit être activé dans l'interface de l'application.	

Commandes en ligne (Si MAX est jumelé avec un téléphone et que le téléphone est en ligne, dites simplement “Hi MAX” pour contrôler toutes les commandes prises en charge par Siri ou Google Assistant.)

Quel temps fait-il aujourd’hui ?

Régler une alarme à neuf heures

Allumer le lecteur de musique

Ouvrir l’application Asmax World

Naviguer vers ma maison

Appeler Berry

Autres commandes prises en charge par Siri/Google Assistant

Perfil

Gracias por elegir el intercomunicador Bluetooth para casco ASMAX con control por voz. Lea atentamente esta guía antes de utilizar el dispositivo.



**Para consultar las instrucciones electrónicas detalladas,
escanee el código QR.**



**Video Tutorial en
YouTube**



**Video de Instrucción de
Actualización de Firmware**

ASMAX WORLD APP

Puede configurar más funciones en su dispositivo ASMAX a través de la aplicación ASMAX WORLD. Escanee el código QR o descárguela desde Google Play Store o Apple App Store.



ASMAX WORLD
App



Download on the
App Store



GET IT ON
Google Play



Web: www.asmaxconnect.com

Contenido del Paquete



Unidad principal
F1 Pro Max



Base de montaje

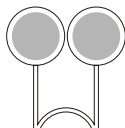

Unidad de altavoz



Placa adhesiva 3M



Abrazadera
de metal



Micrófono con
brazo flexible



Micrófono
con cable



Cable Type-C



Paquete de
limpieza

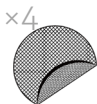

Almohadillas
para altavoz



Velcro para
altavoz



Velcro para
micrófono con cable



Velcro para
micrófono híbrido



Esponja para
micrófono



3M de
repuesto



Manual del usuario

Unidad principal

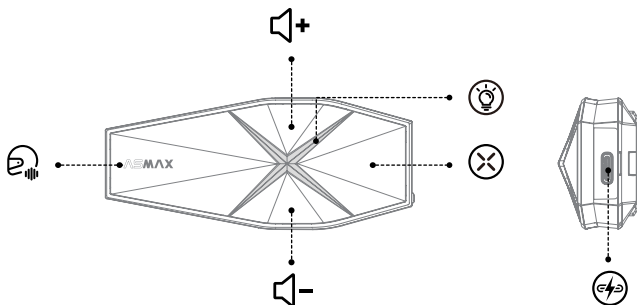





	Volumen +
	Volumen -
	Botón de intercomunicador
	Botón de función
	Indicador LED
	Puerto de carga Type-C

Nota:

- Los intercomunicadores pueden cargarse completamente en 50 minutos (el tiempo de carga puede variar según el entorno de carga).
- No use un cargador con salida superior a 15V para cargar el dispositivo.

Operación rápida

ASMAX tiene dos modos de operación: Voz inteligente y Control por botones. Puede elegir el que se adapte a sus hábitos. Cuando está conectado a la aplicación ASMAX World y a Internet, la unidad principal admite operaciones de voz inteligentes como navegación, envío de mensajes, llamadas y reproducción de música. Cuando no está conectado a Internet, la unidad principal aún puede controlar el dispositivo usando comandos de voz locales integrados.

Función	Palabra de activación	Respuesta de MAX	Comandos sin conexión (Si la unidad principal o el teléfono están sin conexión, MAX solo puede usar comandos sin conexión.)
Encender/ Apagar	/	/	 +    2s
Para controlar la música	Hi Max	Hola/¿Qué necesitas?/¿En qué puedo asistirte?	Encender música
	Hi Max		Pausar música
	Hi Max		Pista anterior
	Hi Max		Siguiente pista
Para controlar el volumen	Hi Max		Subir volumen
	Hi Max		Bajar volumen
Para controlar el teléfono	Hi Max		Responder llamada
	Hi Max		Colgar
Emparejar intercomunicador Bluetooth de otras marcas	Hi Max		Vincular el teléfono

Función	Palabra de activación	Respuesta de MAX	Comandos sin conexión (Si la unidad principal o el teléfono están sin conexión, MAX solo puede usar comandos sin conexión.)
Para el intercomunicador	Hi Max	Hola/¿Qué necesitas?/¿En qué puedo asistirte?	Grupo mesh
	Hi Max		Modo libre
	Hi Max		Modo grupo
	Hi Max		Finalizar intercomunicador
Para la radio	Hi Max		Encender radio
	Hi Max		Apagar radio
	Hi Max		Emisora anterior
	Hi Max		Emisora siguiente
Configuración de red inteligente	Hi Max		Grupo SMC
	Hi Max		Modo SMC
Batería restante	Hi Max		Estado de la batería
Emparejar auriculares Bluetooth de otras marcas	Hi Max		Vinculación universal
Micrófono on/off	Hi Max		Encender el micrófono
	Hi Max		Apagar el micrófono
S'allume automatiquement lorsqu'il est attaché à la base magnétique.		Activez l'interrupteur de contrôle dans l'application.	

Comandos en línea (Si MAX está emparejado con un teléfono y el teléfono está en línea, solo diga “Hi MAX” para controlar cualquier comando compatible con Siri o Google Assistant.)

Cómo está el clima hoy?

Configurar una alarma a las nueve

Encender el reproductor de música

Abrir la aplicación Asmax World

Navegar a mi casa

Llamar a Berry

Otros comandos que soportan Siri/Google Assistant

RF EXPOSURE STATEMENT

This equipment complies with the FCC and ISED radiation exposure limits set forth for an uncontrolled environment. This transmitter must not be co-located or operating in conjunction with any other antenna or transmitter.

Cet équipement est conforme aux limites d'exposition aux rayonnements de la FCC et de l'ISED établies pour un environnement non contrôlé. Cet émetteur ne doit pas être co-localisé ou fonctionner en conjonction avec une autre antenne ou un autre émetteur.

FCC WARNING

This device complies with Part 15 of the FCC Rules. Operation is subject to the following two conditions:

(1) This device may not cause harmful interference, and (2) this device must accept any interference received, including interference that may cause undesired operation.

Note: This equipment has been tested and found to comply with the limits for a Class B digital device, pursuant to part 15 of the FCC Rules. These limits are designed to provide reasonable protection against harmful interference in a residential installation. This equipment generates, uses and can radiate radio frequency energy and, if not installed and used in accordance with the instructions, may cause harmful interference to radio communications. However, there is no guarantee that interference will not occur in a particular installation. If this equipment does cause harmful interference to radio or television reception, which can be determined by turning the equipment off and on, the user is encouraged to try to correct the interference by one or more of the following measures:

- Reorient or relocate the receiving antenna.
- Increase the separation between the equipment and receiver.
- Connect the equipment into an outlet on a circuit different from that to which the receiver is connected.
- Consult the dealer or an experienced radio/TV technician for help.

NOTE 2: Any changes or modifications to this unit not expressly approved by the party responsible for compliance could void the user's authority to operate the equipment.

IC WARNING

This device contains licence-exempt transmitter(s) that comply with Innovation, Science and Economic Development Canada's licence-exempt RSS(s). Operation is subject to the following two conditions:

(1) This device may not cause interference.

(2) This device must accept any interference, including interference that may cause undesired operation of the device.

L'émetteur/récepteur exempt de licence contenu dans le présent appareil est conforme aux CNR d'Innovation, Sciences et Développement économique Canada applicables aux appareils radio exempts de licence. L'exploitation est autorisée aux deux conditions suivantes:

1. L'appareil ne doit pas produire de brouillage;
2. L'appareil doit accepter tout brouillage radioélectrique subi, même si le brouillage est susceptible d'en compromettre le fonctionnement.