

ASMAX

Future 1 & Future 1 EVA R

*Intelligent Helmet Bluetooth
Headset*

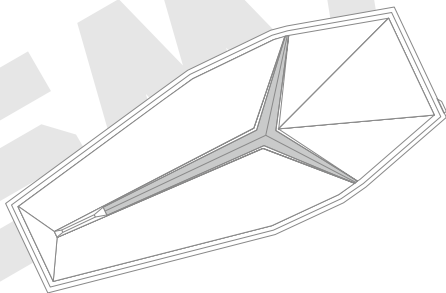

QUICK START GUIDE

V 1.0

FREEDOM IN INFINITE

Scan QR code, more information on official website



www.asmaxconnect.com

Profile

Thank you for choosing the ASMAX voice-controlled helmet Bluetooth intercom. Please read this guide before use.



Bluetooth 5.4



OTA upgrade



10 riders
Mesh intercom



IPX7 waterproof



Group intercom



Fast charge



Universal pairing
Connect with other
brands' Bluetooth



ASMAX World App



Multi-language
Voice Commands



Out/In-Mount Auto Off/On
Set Up On The App



ENC noise reduction

ASMAX WORLD APP

You can configure your ASMAX device more features through the ASMAX WORLD application which can scan the QR code or get from Google Play Store/ Apple App Store.

Download



ASMAX WORLD App

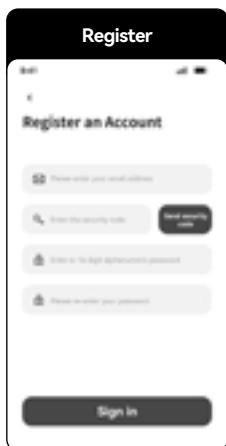

Keeping Update
the Latest Firmware
From APP

Package Contents

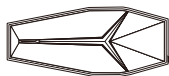

Future 1 Main Unit



Magnet Mount

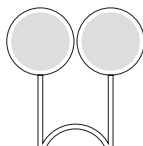

Speaker Unit



3M Glue Plate

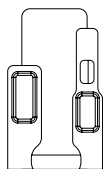

Metal Clamp



Hybrid
Microphone



Wired
Microphone

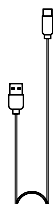

Type-C Cable



Clean Pack



Double sided
Velcro

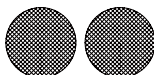

Velcro for
Speaker



Velcro for
Wired Mic



Velcro for
Hybrid Mic



Microphone
Sponge



Manual

Install

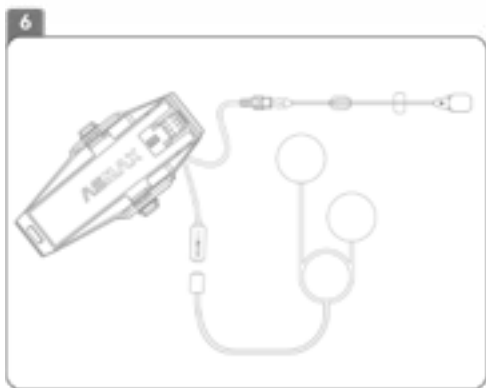

To remove the main unit, please push the two buttons at same time, or just push one button but remove the main unit with reverse direction

Main Unit

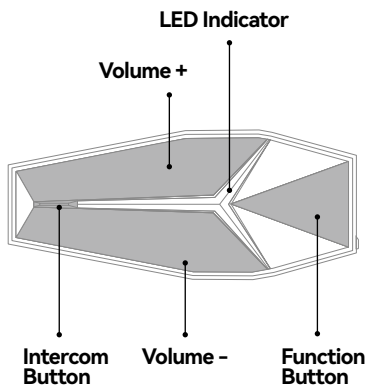

Type-C Charging Port



Note:

- The headset can fully charge within 50mins (The Charging time maybe changed due to charging environment)
- Do not use a charger with an output more than 15V to charge the device.

Basic Operation

Power On / Off

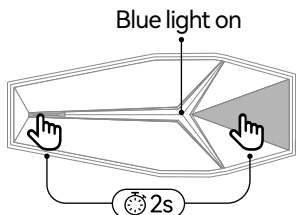

Volume Up / Down

Voice operation



Hi Max, volume up



Hi Max, volume down

You can also:

Key operation

Volume +



x1
Tap

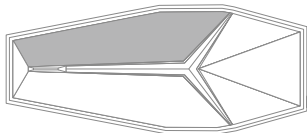

Volume -



x1
Tap

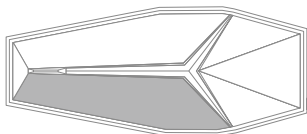

Phone / GPS Pairing

Voice operation



Hi Max, phone pairing

You can also:

Key operation

1



Red and blue lights flashing

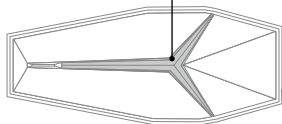
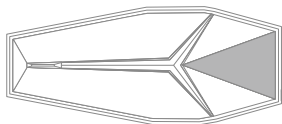

2

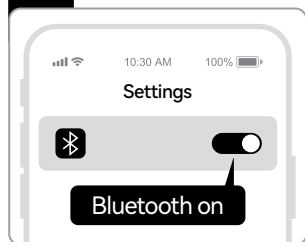

3

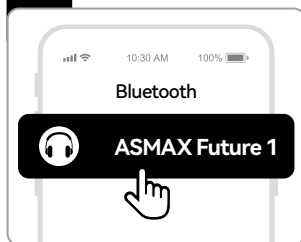

Phone Calls

Answer / End

Voice operation



Hi Max, answer the phone



Hi Max, hang up

You can also:

Key operation

Answer call



End call

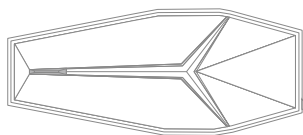
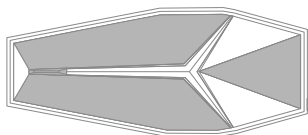

Any button



Reject

Key operation

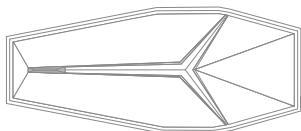
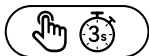

Music

Play / Pause

Voice operation



Hi Max, music on



Hi Max, pause music

You can also:

Key operation

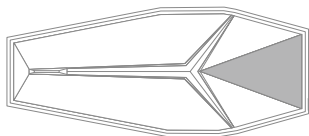

Previous track / Next track

Voice operation



Hi Max, previous track



Hi Max, next track

You can also:

Key operation

Previous track



Next track

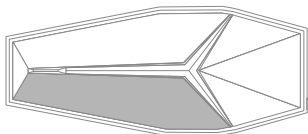
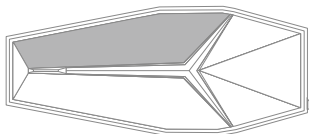

Intercom

Group Mesh

Voice operation



Hi Max, group mesh



Join 2 or N members.

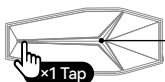

Dark blue light on



Team up.

You can also:

Key operation

Red and blue lights flashing

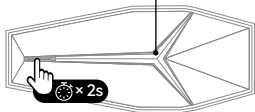

Join 2 or N members.

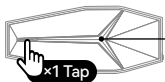

Dark blue light on



Team up.

Group Mode

After Group mesh, you can choose group mode or free mode.

Voice operation



Hi Max, group mode

You can also:

Key operation

Dark blue light on

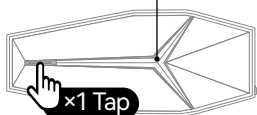

Free Mode

Voice operation



Hi Max, free mode

You can also:

Key operation

Dark blue light on

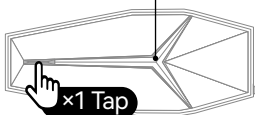

Team Leader mode

In the Group Mode, team leader, head car and tail car which can set a sub-group chat

Team leader mode setting

Team Leader (Team leader which is press the "Intercom Button" to confirm team up.)

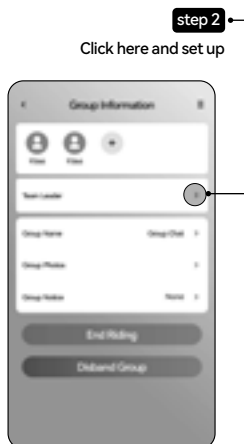
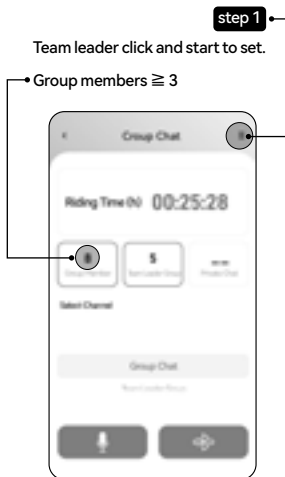

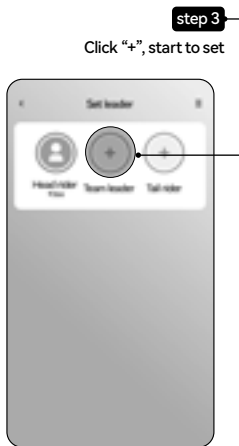

Private chat
All the riders can have 1V1 private chat in the group

Private chat (Any rider)

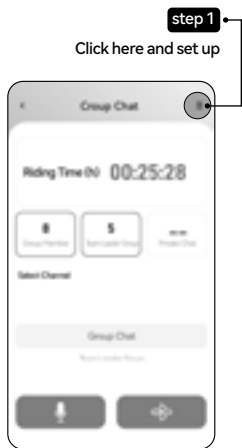

step 2
Click the Profile photo to chose member.

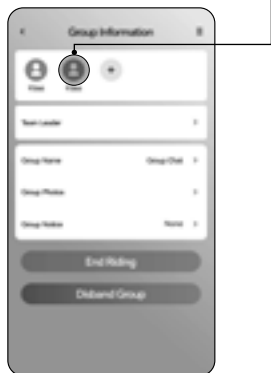

Different mode switch

Key operation

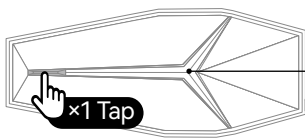

Dark blue light on

Switch from Team Leader mode and Private mode, press and hold 2s.

Leave the mount automatic power off

Operation Tips

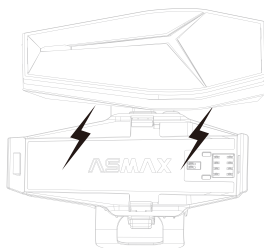
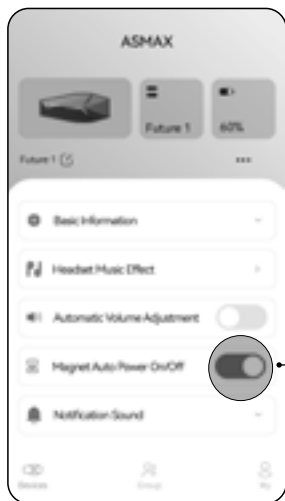

You need to turn on the control switch on the app

Stick on the mount auto power on
leave off the mount auto power off

Universal Mode

Key operation

Enter pairing

1

Red and blue lights flashing

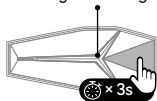

2

Red and green lights flashing

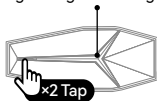

Other brand intercom

3

follow their instruction

Enter pairing mode

Start intercom

4



End Intercom

Voice operation



Hi Max, end intercom

You can also:

Key operation

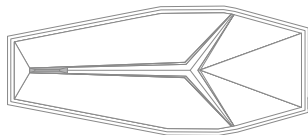

Factory Reset

Key operation

Red light on

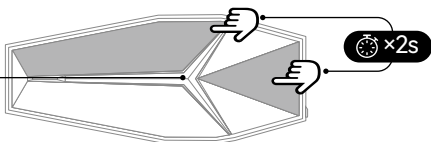

Quick Operation

ASMAX has two operation modes: intelligent voice and buttons, and you can freely choose according to your own habits.

When the main unit is connected to the official ASMAX app and the phone is connected to the internet, the main unit can perform intelligent voice interaction operations such as route navigation, sending messages, making and receiving calls, playing music, and so on.

When not connected to the network, the main unit can perform voice commands through local offline voice commands.

Awakening words **Hi Max**

Function

Voice operation

Or

Key operation

POWER ON/OFF



VOLUME +

Hi max, volume up



VOLUME -

Hi max, volume down



PHONE / GPS PAIRING

Hi max, phone pairing



ANSWER CALL

Hi max, answer the phone



Any button

END CALL

Hi max, hang up



REJECT A CALL



PLAY MUSIC

Hi max, music on



PAUSE MUSIC

Hi max, pause music



PREVIOUS TRACK

























Hi max, previous track



NEXT TRACK

Hi max, next track



Function	Voice operation	Or	Key operation
GROUP MESH	<p>Hi max, group mesh</p> <p>↓</p> <p> Join 2 or N members.</p> <p>↓</p> <p>  (x1)</p> <p>↓</p> <p> Team up.</p>		<p>  (2s)</p> <p>↓</p> <p> Join 2 or N members.</p> <p>↓</p> <p>  (x1)</p> <p>↓</p> <p> Team up.</p>
GROUP MODE	<p>Hi max, group mode</p>		<p>  (x1)</p>
FREE MODE	<p>Hi max, free mode</p>		<p>  (x1)</p>
UNIVERSAL MODE			<p>1 Red and blue lights flashing</p> <p>  (x3s)</p> <p>2 Red and green lights flashing</p> <p>  (x2 Tap)</p> <p>3 follow their instruction</p> <p> Enter pairing mode</p> <p>4  (x2)</p> <p></p>
END INTERCOM	<p>Hi max, end intercom</p>		<p>  (x1)</p>
FACTORY RESET			<p>  (2s)</p>

Scansionate il codice QR per saperne di più sul sito ufficiale



www.asmaxconnect.com 

Profilo

Grazie ancora per aver scelto l'auricolare Bluetooth ASMAX Voice Control Helmet. Prima di utilizzare il dispositivo, leggere le istruzioni per l'uso.



Bluetooth 5.4



Aggiornamento del Firmware



10 Piloti Mesh intercom



IPX7 impermeabile



Interfono gruppo



Ricarica veloce



Collegamento con dispositivi di altre marche



ASMAX World App



Controllo vocale multilingue



Abilita lo spegnimento automatico quando viene rimosso dalla base magnetica nelle impostazioni dell'app.



Cancellazione del rumore ENC

ASMAX WORLD APP

È possibile scansionare il codice QR qui sotto o scaricare e installare ASMAX WORLD dall'app store. Altre funzioni delle impostazioni del dispositivo ASMAX vi aspettano per essere sbloccate.

Scarica



ASMAX WORLD App



Registrazione

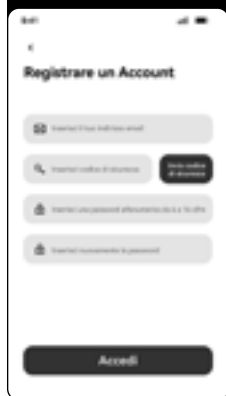

Collegati il tuo dispositivo

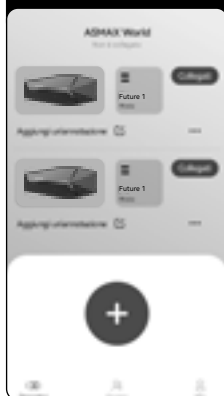

Aggiorna il tuo dispositivo



Mantenere Aggiornato l'ultimo Firmware dall'app

Contenuto Pacchetto



Future 1
principale unità



Supporto
magnetico

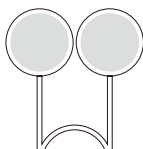

Unità di
altoparlanti



Scheda
colla 3M

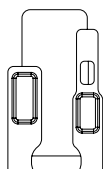

Morsetto in
metallo



Microfono
boom



Microfono
cablato

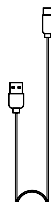

Cavo Tipo C



Pacchetto
pulizia



Velcro doppia
faccia

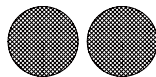

Adesivo
altoparlanti



Adesivo micro-
fono cablato



Adesivo microfono
piu' bassa



Spugna
microfonica



Manuale

Installare

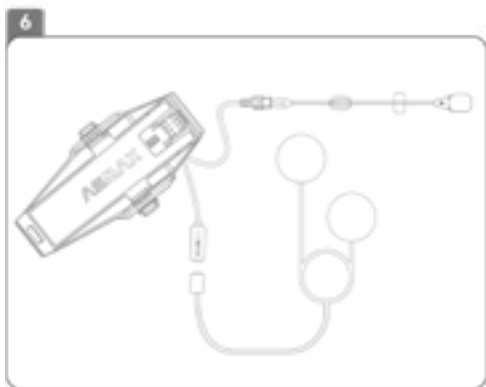

Per rimuovere l'unità principale, premere contemporaneamente i due pulsanti, oppure premere un solo pulsante ma rimuovere l'unità principale in senso inverso.

Unità principale

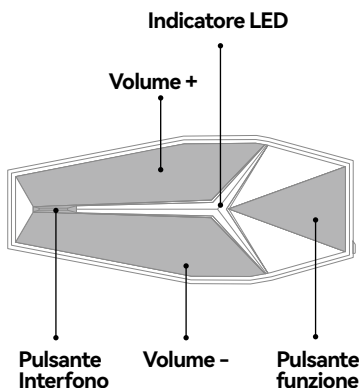

Porta di ricarica di Tipo C



Osservazione:

- L'auricolare può essere completamente caricato in 50 minuti (carica l'ora potrebbe cambiare a causa dell'ambiente di ricarica).
- Non utilizzare un caricabatterie con una potenza superiore a 15 V per caricare il dispositivo.

Operazioni Base

Potenza Di Acceso/Spento

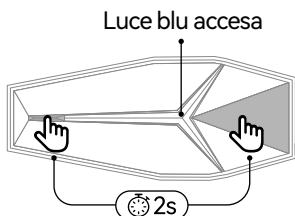

Aumento/Diminuzione del Volume

Comando vocale



Hi Max, volume up



Hi Max, volume down

Puoi anche:

Operazione chiave

Volume +

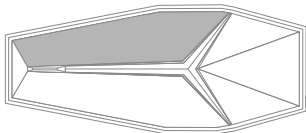

Volume -

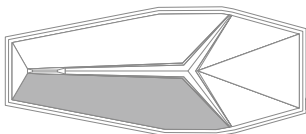

Accoppiamento Telefono/Gps

Comando vocale



Hi Max, Phone Pairing

Puoi anche:

Operazione chiave

1

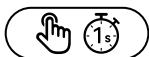

Luci rosse e blu lampeggianti

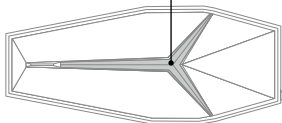
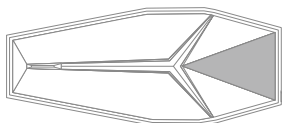

2



3

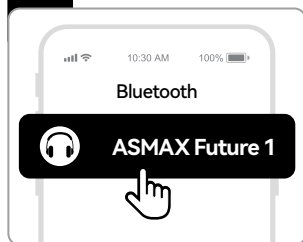

Telefono Chiamate

Risposta / Fine

Comando vocale



Hi Max, answer the phone



Hi Max, hang up

Puoi anche:

Operazione chiave

Rispondi alla chiamata  (x1)
Premere

Fine chiamata  (x1)
Premere

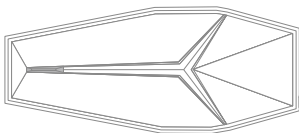
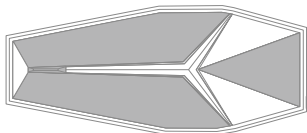

Qualsiasi pulsante



Rifiuta una chiamata

Operazione chiave

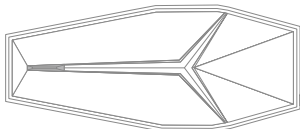
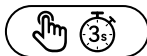

Musica

Riproduci/Pausa

Comando vocale



Hi Max, music on



Hi Max, pause music

Puoi anche:

Operazione chiave

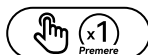
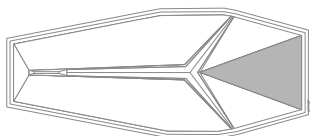

traccia precedente / prossima traccia

Comando vocale





Hi Max, previous track





Hi Max, next track

Puoi anche:

Operazione chiave

Traccia precedente  

Prossima traccia  

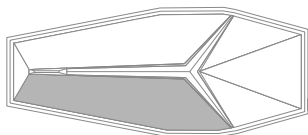
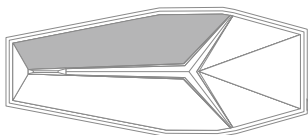

Interfono

Group Mesh

Comando vocale



Hi Max, group mesh



Unisciti a 2 o N membri



Luce blu scuro accesa



Partecipa

Puoi anche:

Operazione chiave

Luci rosse e blu lampeggianti

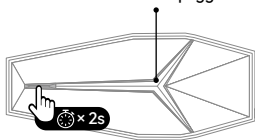

Unisciti a 2 o N membri.



Luce blu scuro accesa



Partecipa

Modalità gruppo

Dopo la generazione della rete di gruppo, è possibile scegliere la modalità di gruppo o la modalità libera.

Comando vocale



Hi Max, group mode

Puoi anche:

Operazione chiave

Luce blu scuro accesa

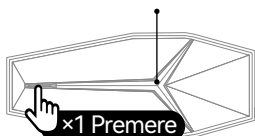

Modalità libera

Comando vocale



Hi Max, free mode

Puoi anche:

Operazione chiave

Luce blu scuro accesa

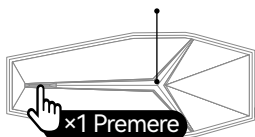

I. Modalità Leader

Modalità Leader

in modalità Team, il leader e i 3 piloti della prima e dell'ultima vettura possono creare un "sottogruppo" per parlare tra loro

Impostazioni della modalità Leader

Leader del gruppo (durante il processo di formazione del gruppo, il pilota che preme il "pulsante interfono" per confermare il completamento del gruppo diventerà automaticamente il leader del gruppo).

Passi 1

Il proprietario del gruppo clicca qui per avviare la configurazione

• Dimensione della chat di gruppo ≥ 3

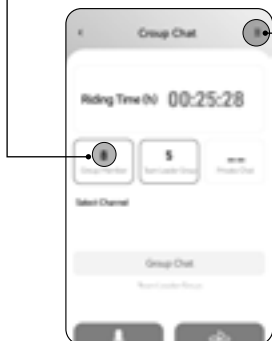

Passi 2

Fare clic qui per avviare le impostazioni

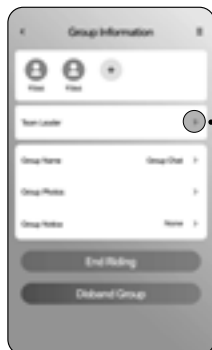

Passi 3

Vai a questa pagina e clicca su "+" per avviare le impostazioni

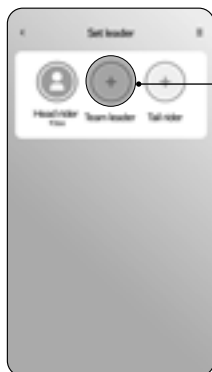

Chat privata

qualsiasi pilota, chat privata 1v1 in modalità gruppo

Impostazioni della chat privata (qualsiasi pilota)

Passi 1

Fare clic qui per avviare le impostazioni

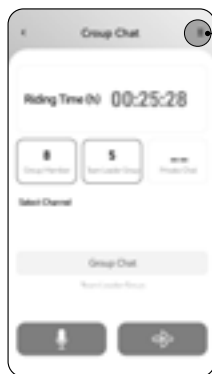

Passi 2

Fare clic sul proprio avatar per selezionare i membri della chat privata.

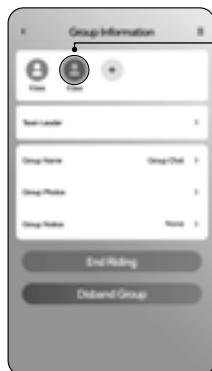

Commutazione dell'interfono in diverse modalità

Operazione chiave

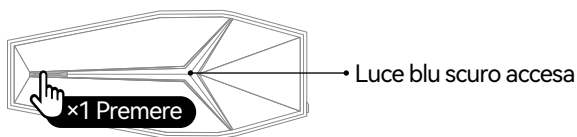

Passa tra Modalità Leader e Modalità Privata premendo e tenendo premuto per 2 secondi.

Interruttore di Controllo per Base Magnetica.

Suggerimenti per l'operazione

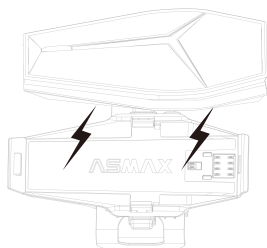
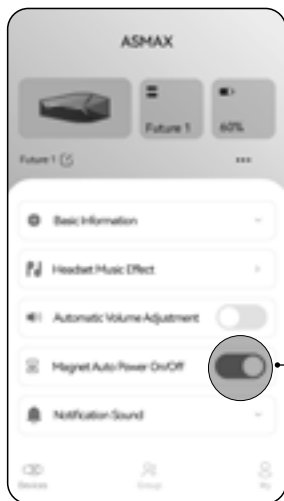

Abilita l'interruttore di controllo nell'app.

Si accende automaticamente quando è collegato alla base magnetica.

Modalità universale

Operazione chiave

Inserisci l'accoppiamento

1

Luci rosse e blu lampeggianti

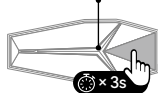

2

Luci rosse e verdi lampeggianti



Interfono di un'altra marca

3

Segui le loro istruzioni

Inserisci la modalità di accoppiamento

Avvia l'interfono

4



Fine dell'interfono

Comando vocale



Hi Max, end intercom

Puoi anche:

Operazione chiave

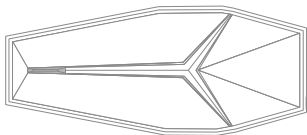

Restauro fabbrica

Operazione chiave

Luce rossa accesa

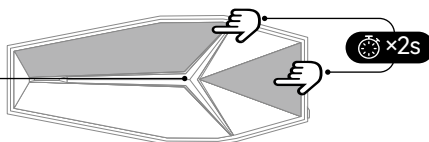

Operazione veloce























ASMAX è dotato sia di comandi vocali intelligenti che di pulsanti, che si possono scegliere liberamente in base alle proprie abitudini.

























Quando l'main unit è connesso all'APP ufficiale ASMAX e il telefono cellulare è connesso alla rete, l'main unit può eseguire la navigazione del percorso, inviare messaggi, rispondere alle chiamate, riprodurre musica e altre operazioni di interazione vocale intelligente.

Quando non è connesso alla rete, l'main unit può eseguire operazioni vocali attraverso i seguenti vocali locali offline.

Parola di risveglio

Hi Max

Funzione	Comando vocale	O	Operazione chiave
POTENZA DI ACCESO/ SPENTO			
VOLUME +	Hi max, volume up		
VOLUME -	Hi max, volume down		
ACCOPPIAMENTO TELEFONO/GPS	Hi max, phone pairing		
RISPONDI ALLA CHIAMATA	Hi max, answer the phone		 Qualsiasi pulsante
FINE CHIAMATA	Hi max, hang up		
RIFIUTA UNA CHIAMATA			
RIPRODURRE MUSICA	Hi max, music on		
METTERE IN PAUSA LA MUSICA	Hi max, pause music		
TRACCIA PRECEDENTE	Hi max, previous track		
PROSSIMA TRACCIA	Hi max, next track		

Funzione	Comando vocale	O	Operazione chiave
GROUP MESH	Hi max, group mesh ↓  Unisciti a 2 o N membri. ↓   ↓  Partecipa	O	  ↓  Unisciti a 2 o N membri. ↓   ↓  Partecipa
MODALITÀ GRUPPO	Hi max, group mode		 
MODALITÀ LIBERA	Hi max, free mode		 
MODALITÀ UNIVERSALE			<ol style="list-style-type: none"> 1  Luci rosse e blu lampeggianti  2  Luci rosse e verdi lampeggianti  3  Segui le loro istruzioni 4   Inserisci la modalità di accoppiamento
FINE DELL'INTERFONO	Hi max, end intercom		 
RIPRISTINO DI FABBRICA			 

Scannez le code QR pour en savoir plus sur le site officiel



www.asmaxconnect.com 

Profil

Merci d'avoir choisi l'oreillette ASMAX Voice Control Helmet Bluetooth Headset. Veuillez lire le manuel d'utilisation avant d'utiliser l'appareil.



Bluetooth 5.4



Mise à jour du micrologiciel



10 Coureurs
Mesh intercom



IPX7 étanche



Interphone de groupe



Chargement rapide



Connexion avec d'autres
marques d'appareils



ASMAX World App



Commande vocale
multilingue



Réglage de l'arrêt automatique
lorsque l'on quitte la base
magnétique par l'App



Annulation du bruit ENC

ASMAX WORLD APP

Vous pouvez soit scanner le code QR ci-dessous, soit télécharger et installer ASMAX WORLD depuis le magasin d'applications.

Télécharger



ASMAX WORLD App

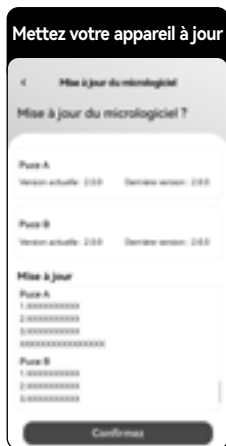

Continuez à mettre à jour le micrologiciel le plus récent à partir de l'APP

Contenu de l'emballage



Unité principale
Future 1



Support
magnétique

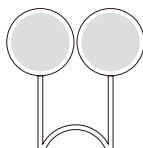

Haut-parleur



Plaque de
colle 3M

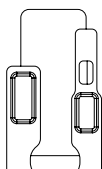

Pince
métallique



Microphone
à perche



Microphone filaire

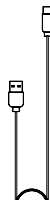

Câble Type-C



Pack de
nettoyage



Velcro à double
face

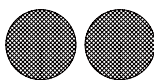

Autocollant pour
haut-parleur



Autocollant pour
micro à fil



Autocollant pour
micro à perche



Éponge pour
microphone



Manuel

Installer

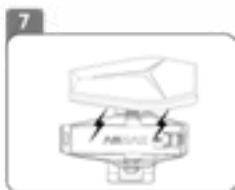
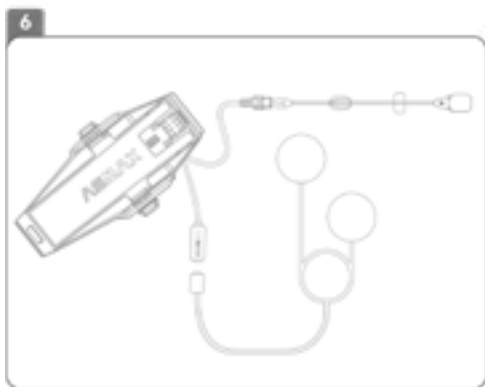

Pour retirer l'unité principale, appuyez sur les deux boutons en même temps, ou appuyez simplement sur un bouton mais retirez l'unité principale dans le sens inverse.

Unité principale

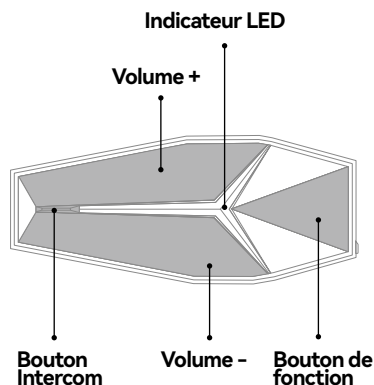

Port de charge de Type C



Remarque :

- Le casque peut se recharger complètement en 50 minutes (La durée de charge est susceptible de varier en fonction de l'environnement de charge)
- N'utilisez pas un chargeur avec une alimentation supérieure à 15 V pour charger l'appareil.

Opérations de base

Marche/Arrêt

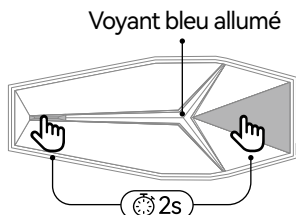

Augmentation/baisse du volume

Fonctionnement vocal



Hi Max, volume up

Hi Max, volume down

Vous pouvez également :

Utilisation des touches

Volume +



x1
Tapez

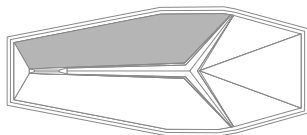

Volume -



x1
Tapez

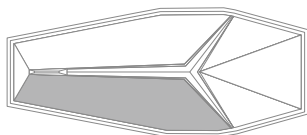

Appairage téléphone / GPS

Fonctionnement vocal



Hi Max, phone pairing

Vous pouvez également :

Utilisation des touches

1

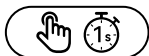

Voyants rouge et bleu clignotants

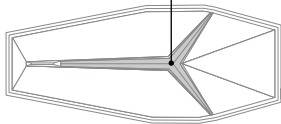
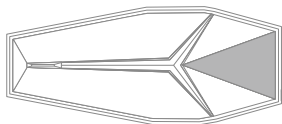

2

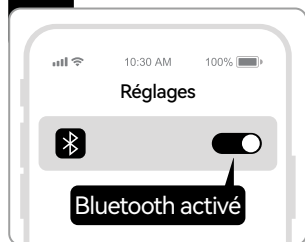

3

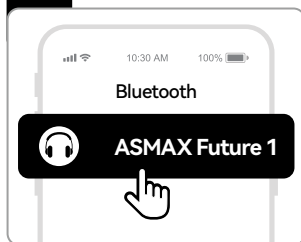

Appels téléphoniques

Répondre / Terminer

Fonctionnement vocal



Hi Max, answer the phone



Hi Max, hang up

Vous pouvez également :

Utilisation des touches

Repondre a l'appel



x1
Tapez

Fin de l'appel



x1
Tapez

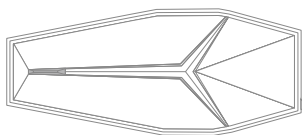
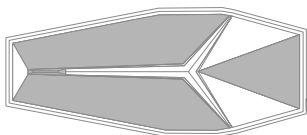

N'importe quelle touche



Rejeter un appel

Utilisation des touches

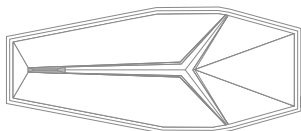
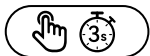

Musique

Jouer / Pause

Fonctionnement vocal



Hi Max, music on



Hi Max, pause music

Vous pouvez également :

Utilisation des touches

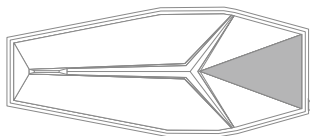

Piste précédente / Piste suivante

Fonctionnement vocal



Hi Max, previous track



Hi Max, next track

Vous pouvez également :

Utilisation des touches

Piste précédente



Piste suivante

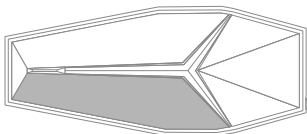
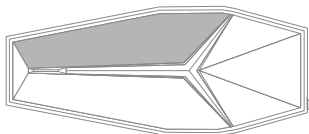

Interphone

Group Mesh

Fonctionnement vocal



Hi Max, group mesh



Rejoindre 2 ou N membres

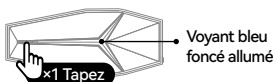

Former une équipe

Vous pouvez également :

Utilisation des touches

Voyants rouge et bleu clignotants

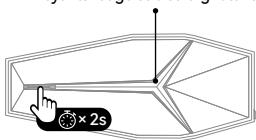

Rejoindre 2 ou N membres.

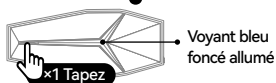

Former une équipe

Mode groupe

Après le réseau de groupe, vous pouvez choisir le mode groupe ou le mode libre.

Fonctionnement vocal



Hi Max, group mode

Vous pouvez également :

Utilisation des touches

Voyant bleu foncé allumé

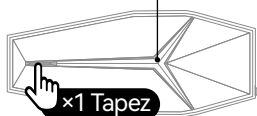

Mode libre

Fonctionnement vocal



Hi Max, free mode

Vous pouvez également :

Utilisation des touches

Voyant bleu foncé allumé

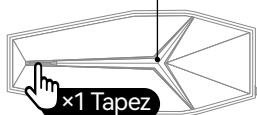

I. Mode Leader Mode Leader

en mode Team, le leader et les 3 coureurs de la première et de la dernière voiture peuvent créer un "sous-groupe" pour se parler

Paramètres du mode Leader

Chef de groupe (pendant le processus de formation du groupe, le coureur qui appuie sur le "bouton intercom" pour confirmer la formation du groupe devient automatiquement le chef de groupe).

Etapas 1

Le propriétaire du groupe clique ici pour démarrer la configuration.

Taille du groupe de discussion ≥ 3

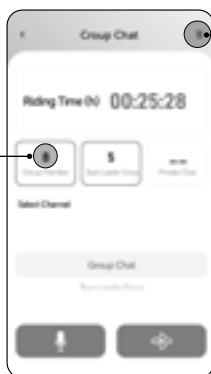

Etapas 2

Cliquez ici pour commencer les réglages

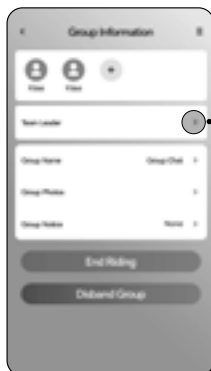

Etapas 3

Allez sur cette page et cliquez sur "+" pour commencer les réglages

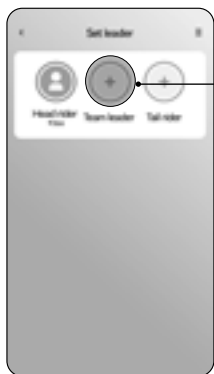

Chat privé

n'importe quel coureur, chat privé
1v1 en mode groupe

Paramètres du chat privé (tous les coureurs)

Etapas 1

Cliquez ici pour commencer les réglages

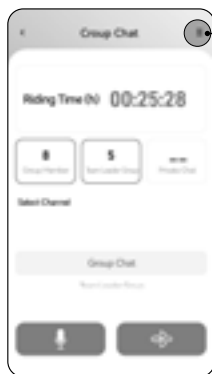

Etapas 2

Cliquez sur votre avatar pour sélectionner les membres du chat privé

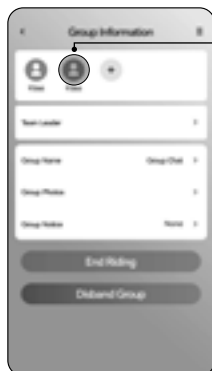

Commutation de l'intercom dans différents modes

Utilisation des touches

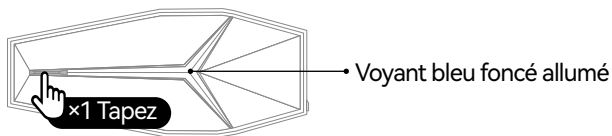

Commutation entre le mode leader et le mode privé, appui pendant 2s

Interrupteur marche/arrêt de la base magnétique

Instructions d'opération

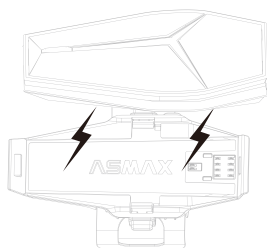
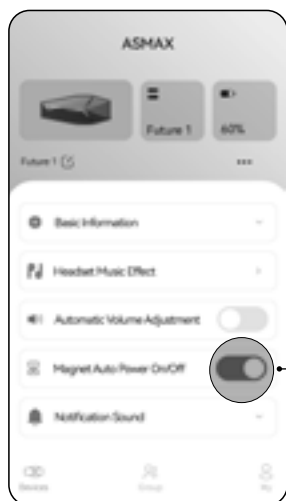

L'interrupteur de contrôle doit être activé dans l'interface de l'application.

Mise en marche automatique magnétique, arrêt automatique lorsque l'on quitte la base

Mode universel

Utilisation des touches

Entrer dans l'appairage

1

Voyants rouge
et bleu clignotants

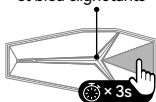

2

Voyants rouge
et vert clignotants

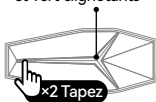

Interphone d'une autre marque

3

suivre leurs instructions

Entrer dans le mode
d'appairage

Démarrer l'interphone

4

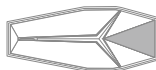
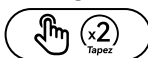

Fin Intercom

Fonctionnement vocal



Hi Max, end intercom

Vous pouvez également :

Utilisation des touches

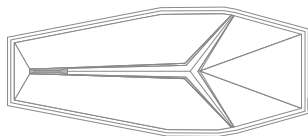
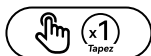

Réinitialisation usine

Utilisation des touches

Voyant rouge allumé

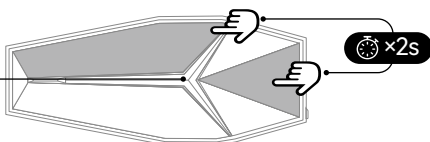























Utilisation rapide























L'ASMAX dispose d'une commande vocale intelligente et d'une commande par touches, que vous pouvez choisir librement en fonction de vos habitudes.

Lorsqu'hôte est connecté à APP ASMAX officielle et que le téléphone portable est connecté au réseau, hôte peut effectuer des opérations d'interaction vocale intelligentes telles que la navigation, l'envoi de messages, la réponse à des appels téléphoniques, la lecture de musique, etc.

Lorsqu'il n'est pas connecté au réseau, l'hôte peut effectuer des opérations vocales à l'aide des commandes locales hors ligne suivantes.

Mot de réveil **Hi Max**

Fonction	Fonctionnement vocal	Ou	Utilisation des touches
MARCHE/ARRÊT			 
VOLUME +	Hi max, volume up		 
VOLUME -	Hi max, volume down		 
APPAIRAGE TÉLÉPHONE / GPS	Hi max, phone pairing		 
REPONDRE A L'APPEL	Hi max, answer the phone		  N'importe quelle touche
FIN DE L'APPEL	Hi max, hang up		 
REJETER UN APPEL			 
LIRE LA MUSIQUE	Hi max, music on		 
PAUSE MUSIQUE	Hi max, pause music		 
PISTE PRÉCÉDENTE	Hi max, previous track		 
PISTE SUIVANTE	Hi max, next track		 

Fonction	Fonctionnement vocal	Ou	Utilisation des touches
GROUP MESH	<p>Hi max, group mesh</p> <p>↓</p> <p> Rejoindre 2 ou N membres.</p> <p>↓</p> <p> </p> <p>↓</p> <p> Former une équipe</p>		<p> </p> <p>↓</p> <p> Rejoindre 2 ou N membres.</p> <p>↓</p> <p> </p> <p>↓</p> <p> Former une équipe</p>
MODE GROUPE	<p>Hi max, group mode</p>		<p> </p>
MODE LIBRE	<p>Hi max, free mode</p>		<p> </p>
MODE UNIVERSEL			<p>1 Voyants rouge et bleu clignotants  </p> <p>2 Voyants rouge et vert clignotants   Tapez</p> <p>3 suivre leurs instructions</p> <p>4 Entrer dans le mode d'appairage  </p>
FIN INTERCOM	<p>Hi max, end intercom</p>		<p> </p>
RÉINITIALISATION USINE			<p> </p>

Scannen Sie den QR-Code und erfahren Sie mehr auf der offiziellen Website



www.asmaxconnect.com 

Profil

Nochmals vielen Dank, dass Sie sich für das ASMAX Voice Control Helmet Bluetooth Headset entschieden haben. Bitte lesen Sie die Bedienungsanleitung, bevor Sie das Gerät benutzen.



Bluetooth 5.4



Firmware aktualisieren



10 Fahrer Mesh intercom



IPX7 wasserdicht



Gruppen Sprechanlage



Schnellladefunktion



Verbindung mit Geräten anderer Hersteller



ASMAX World App



Mehrsprachige Sprachsteuerung



In der App wird eingestellt, dass sich das Gerät automatisch ausschaltet, wenn es den Magnetsockel verlässt.



ENC-Geräuschunterdrückung

ASMAX WORLD APP

Sie können entweder den QR-Code unten scannen oder ASMAX WORLD aus dem App-Store herunterladen und installieren, um weitere Funktionen der ASMAX Geräteeinstellungen freizuschalten.

herunterladen



ASMAX WORLD App

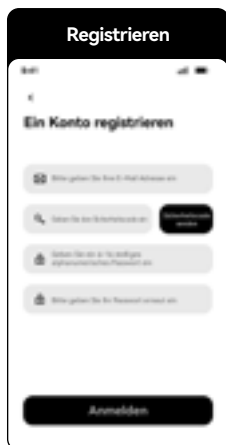

Holen Sie sich das neueste Firmware über die APP

Lieferumfang



Future 1
Headset Haupteinheit



Magnetisches
Montagegestell

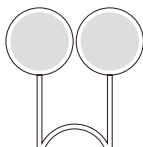

Lautsprecher



3M Klebeplatte

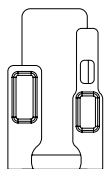

Metallklammer



Kabelgebundenes
Bügel-Mikrofon



Kabelgebundenes
Mikrofon

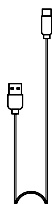

Typ C Ladekabel

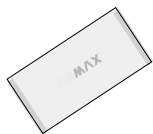

Reinigungsutensilien



Doppelseitiges
Klettband

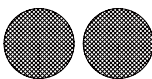

Sticker für
Lautsprecher



Sticker für
Kabelgebundenes
Mikrofon



Sticker für
Schwanenhals-Mikrofon



Schaumstoffkappe
für Mikrofon



Bedienungsanleitung

Installieren

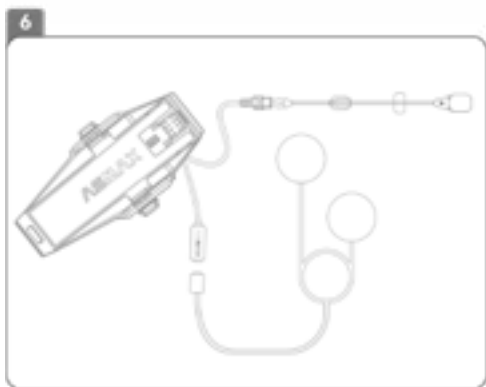

Um die Haupteinheit zu entfernen, drücken Sie bitte die beiden Knöpfe gleichzeitig, oder drücken Sie nur einen Knopf, aber entfernen Sie die Haupteinheit in umgekehrter Richtung

Headset Haupteinheit

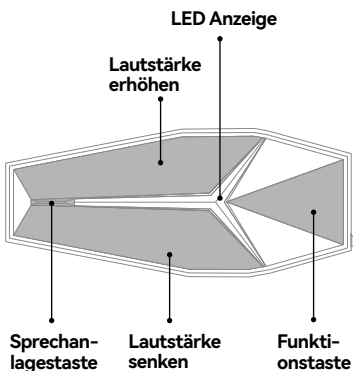

Typ C Ladeanschluss



Hinweis:

- Headset kann innerhalb von 50 Minuten vollständig aufgeladen werden (Die Ladezeit kann sich aufgrund der Ladeumgebung ändern.)
- Verwenden Sie keine Ladegeräte mit einer Ausgangsspannung von mehr als 15V, um das Gerät aufzuladen.

Grundlegende Bedienung

Ein-/Aus-switchen

Blaue Lampe leuchtet

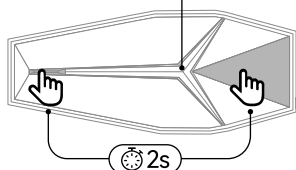

Lautstärke erhöhen/senken

Sprachsteuerung



Hi Max, volume up



Hi Max, volume down

Sie können auch:

Taste bedienen

Lautstärke erhöhen

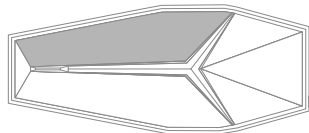

Lautstärke senken

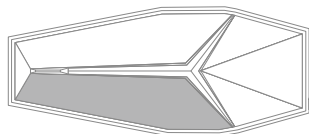

Handy/GPS koppeln

Sprachsteuerung



Hi Max, phone pairing

Sie können auch:

Taste bedienen

1



Rotes und blaues Licht blinken

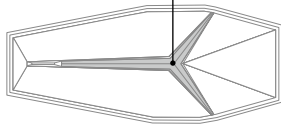
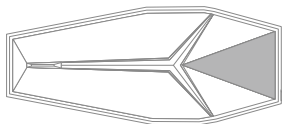

2



3

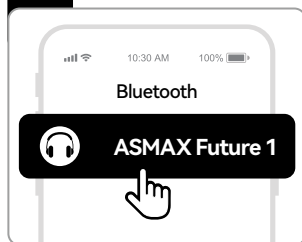

Telefongespräch

annehmen/beenden

Sprachsteuerung



Hi Max, answer the phone



Hi Max, hang up

Sie können auch:

Taste bedienen

Anruf annehmen



(x1)
Antippen

Anruf beenden



(x1)
Antippen

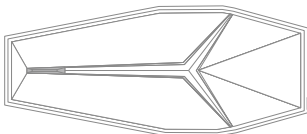
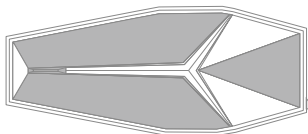

Jede Taste



Anruf ablehnen

Taste bedienen

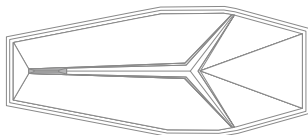
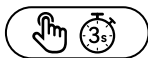

Musik

Wiedergabe/Pause

Sprachsteuerung



Hi Max, music on



Hi Max, pause music

Sie können auch:

Taste bedienen

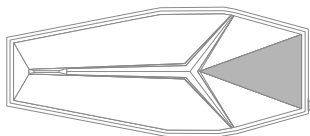

Zum vorherigen Titel wechseln/Nächster Titel

Sprachsteuerung



Hi Max, previous track



Hi Max, next track

Sie können auch:

Taste bedienen

Zum vorherigen
Titel wechseln



Zum nächsten
Titel wechseln

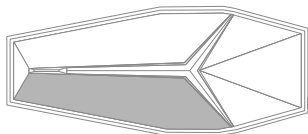
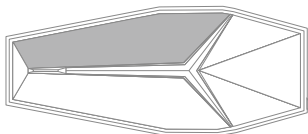

Sprechanlage

Mesh Gruppen

Sprachsteuerung



Hi Max, group mesh



Join 2 or N members



Dunkelblaue
Lampe leuchtet



Team up

Sie können auch:

Taste bedienen

Rotes und blaues Licht blinken

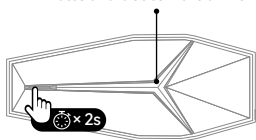

Join 2 or N members



Dunkelblaue
Lampe leuchtet



Team up

Gruppenmodus

Nach dem Gruppen Mesh können Sie den Gruppenmodus oder den Freiemodus auswählen.

Sprachsteuerung



Hi Max, group mode

Sie können auch:

Taste bedienen

Dunkelblaue Lampe leuchtet

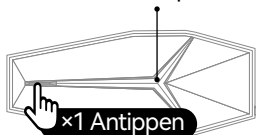

x1 Antippen

Freiemodus

Sprachsteuerung



Hi Max, free mode

Sie können auch:

Taste bedienen

Dunkelblaue Lampe leuchtet

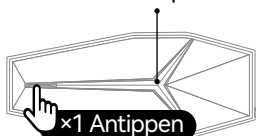

x1 Antippen

Anführer-Modus Anführer-Modus

im Team-Modus können der Anführer und die 3 Fahrer des ersten und letzten Wagens eine "Untergruppe" einrichten, um miteinander zu sprechen

Einstellungen für den Anführer-Modus

Gruppenleiter (Während der Gruppenbildung wird der Fahrer, der die "Intercom-Taste" drückt, um die Fertigstellung der Gruppe zu bestätigen, automatisch zum Gruppenleiter).

Schritte 1

Der Gruppenbesitzer klickt hier, um die Einrichtung zu starten

•Gruppenchatgröße ≥ 3

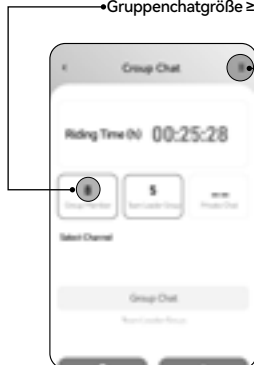

Schritte 2

Klicken Sie hier, um die Einstellung zu starten

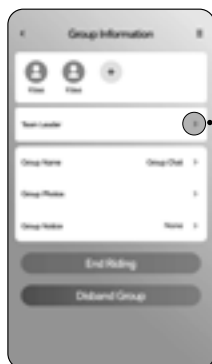

Schritte 3

Gehen Sie auf diese Seite und klicken Sie auf "+", um die Einstellungen zu starten



Private chat

jeder Fahrer, 1v1 privater Chat im Gruppenmodus

Private Chat-Einstellungen (beliebiger Fahrer)

Schritte 1

Klicken Sie hier, um die Einstellung zu starten



Schritte 2

Klicken Sie auf Ihren Avatar, um private Chat-Mitglieder auszuwählen

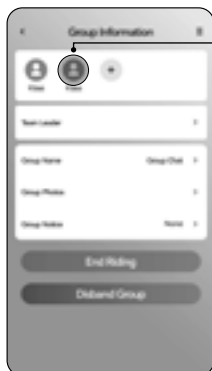

Interkom-Umschaltung in verschiedenen Modi

Taste bedienen

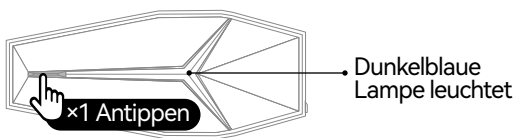

Zum Wechseln zwischen Führungsmodus und Privatmodus die Taste 2s lang gedrückt halten

Ein- und Ausschalten über Magnetsockel

Bedienungshinweise

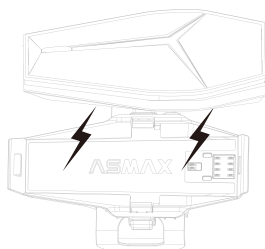
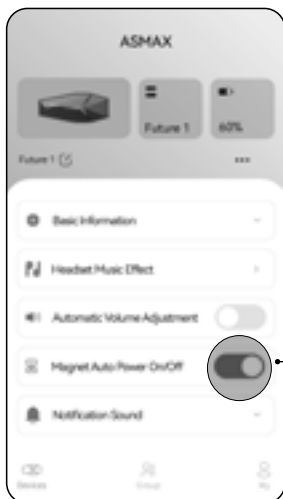

Der Kontrollschalter muss in der App-Oberfläche aktiviert werden

Automatisches Einschalten durch magnetische Saugkraft, automatisches Ausschalten durch Entfernen vom Sockel

Universelles Modus

Taste bedienen

Paarungseinstellung

1

Rotes und blaues
Licht blinken

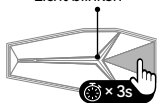

2

Rotes und grünes
Licht blinken

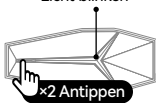

Gegensprechanlage anderer Marken

3

folgen Sie ihren
Anweisungen

Universelle Paarung

Sprechanlage beginnen

4

Antippen
x2



Sprechanlage beenden

Sprachsteuerung



Hi Max, end intercom

Sie können auch:

Taste bedienen

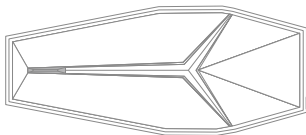

Werkseinstellungen wiederherstellen

Taste bedienen

Rote Lampe leuchtet

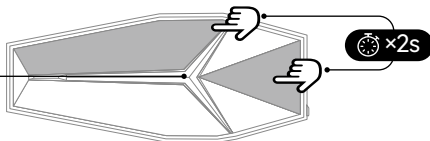

Schnelle Bedienung

ASMAX bietet sowohl intelligente Sprachbefehle als auch Tastenbedienung. Sie können je nach Ihren Gewohnheiten zwischen diesen beiden Modi wählen.

Wenn der Kopfhörer mit der ASMAX APP verbunden ist und das Smartphone online ist, kann der Kopfhörer intelligente Sprachbefehle ausführen wie Navigation, Senden von Nachrichten, Annehmen/Entgegennehmen von Anrufen sowie Abspielen von Musik usw.

Ohne eine Internetverbindung des Telefons kann der Kopfhörer auch über Offline Sprachbefehle bedient werden.

Aktivierungswort

Hi Max

Funktion

Sprachsteuerung

oder

Taste bedienen

Einschalten/ Ausschalten



Lautstärke erhöhen

Hi max, volume up



Lautstärke senken

Hi max, volume down



Handy/GPS koppeln

Hi max, phone pairing



Anruf annehmen

Hi max, answer the phone



Jede Taste

Anruf beenden

Hi max, hang up



Anruf ablehnen



Musik wiedergeben

Hi max, music on



Musik pausieren

Hi max, pause music



Zum vorherigen Titel wechseln





















Hi max, previous track



Nächster Titel

Hi max, next track



Funktion	Sprachsteuerung	oder	Taste bedienen
MESH GRUPPEN	<p>Hi max, group mesh</p> <p>↓</p> <p> Join 2 or N members</p> <p>↓</p> <p> </p> <p>↓</p> <p> Team up</p>	<p> </p> <p>↓</p> <p> Join 2 or N members</p> <p>↓</p> <p> </p> <p>↓</p> <p> Team up</p>	
GRUPPENMODUS	<p>Hi max, group mode</p>	<p> </p>	
FREIEMODUS	<p>Hi max, free mode</p>	<p> </p>	
UNIVERSELLES MODUS		<p>1 Rotes und blaues Licht blinken</p> <p>2 Rotes und grünes Licht blinken</p> <p>3 folgen Sie ihren Anweisungen</p> <p>4 </p> <p>Universelle Paarung </p>	
SPRECHANLAGE BEENDEN	<p>Hi max, end intercom</p>	<p> </p>	
WERKSEINSTELLUNGEN WIEDERHERSTELLEN		<p> </p>	

Escanee el código QR para obtener más información en el sitio web oficial



www.asmaxconnect.com 

Perfil

Gracias de nuevo por elegir los Auriculares Bluetooth para Casco con Control de Voz ASMAX. Por favor, lea el manual de instrucciones antes de usar el dispositivo.



Bluetooth 5.4



Actualización de Firmware



10 Pilots Mesh intercom



IPX7 resistente al agua



Intercomunicador grupal



Carga Rapida



Conexión con dispositivos de otras marcas



ASMAX World App



Control por voz en varios idiomas



Activez la mise hors tension automatique lorsqu'il est retiré de la base magnétique dans les paramètres de l'application.



Cancelación de ruido ENC

ASMAX WORLD APP

Puedes escanear el código QR que aparece a continuación o descargar e instalar ASMAX WORLD desde la tienda de aplicaciones.

Descargar



ASMAX WORLD App

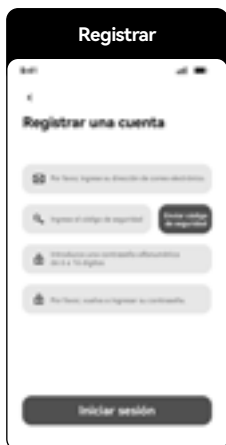

Manteniendo Actualizado el Firmware más Reciente desde APP

Contenidos del Paquete

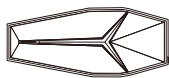

Future 1
Unidad principal



Soporte magnético

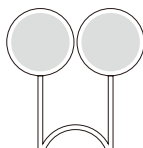

Unidad de altavoz



3M almohadilla
adhesiva

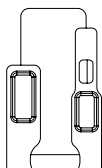

Abrazadera
metálica



Micrófono boom



Micrófono
con cable

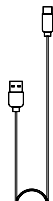

Cable tipo C



Paquete de limpieza



Doble cara de
Velcro

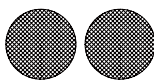

Almohadillas de
velcro para altavoz



Almohadilla de velcro
para micrófono con
cable



Almohadilla de velcro
para micrófono boom



Esponja para
micrófono



Manual

Instalar

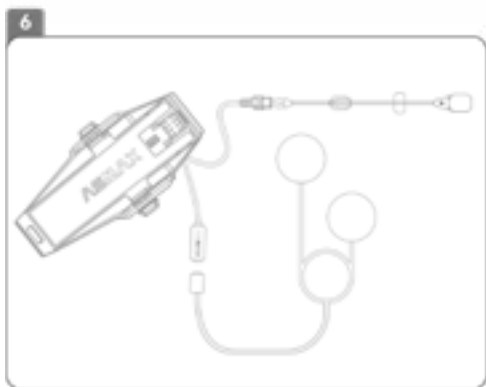

Para extraer la unidad principal, pulse los dos botones a la vez, o bien pulse un solo botón pero extraiga la unidad principal en sentido inverso.

Unidad principal

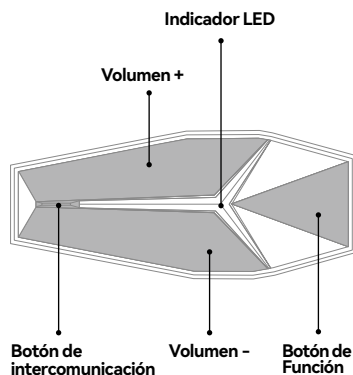

Puerto de Carga Tipo C



Note:

- Los auriculares se pueden cargar completamente en 50 minutos (el tiempo de carga puede cambiar debido al entorno de carga)
- No utilice un cargador con una salida superior a 15 V para cargar el dispositivo.

Operaciones Básicas

Encender / Apagar

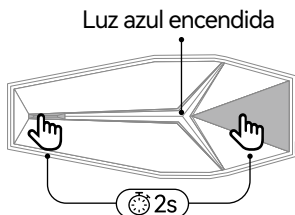

Subir/Bajar el Volumen

Control por voz



Hi Max, volume up

Hi Max, volume down

También puedes:

Operación clave

Volumen +

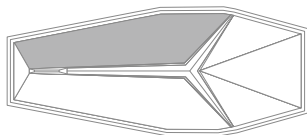

Volumen -

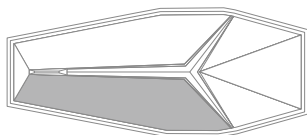

Emparejar Teléfono/GPS

Control por voz



Hi Max, phone pairing

También puedes:

Operación clave

1

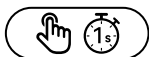

Luces roja y azul parpadeando

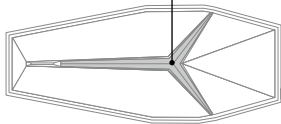
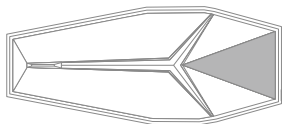

2



3

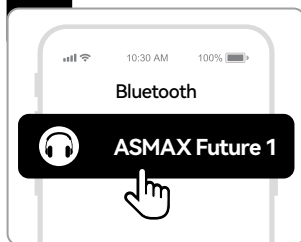

Llamadas Telefónicas

Responder/Finalizar

Control por voz



Hi Max, answer the phone



Hi Max, hang up

También puedes:

Operación clave

Responder a
una llamada



Finalizar
una llamada

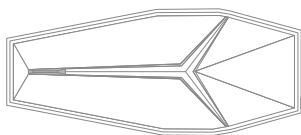
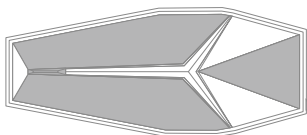

Cualquier botón



Rechazar una llamada

Operación clave

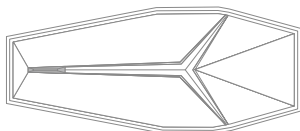
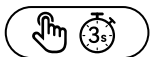

Música

Reproducir/Pausar

Control por voz



Hi Max, music on



Hi Max, pause music

También puedes:

Operación clave

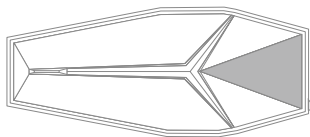

Pista anterior/Pista siguiente

Control por voz



Hi Max, previous track



Hi Max, next track

También puedes:

Operación clave

Pista anterior



Pista siguiente

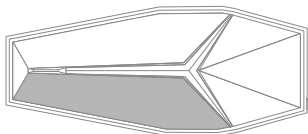
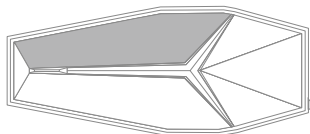

Intercomunicador

Group Mesh

Control por voz



Hi Max, group mesh



Únase a 2 o N miembros

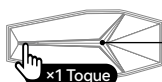

Luz azul oscuro encendida



Forma un equipo

También puedes:

Operación clave

Luces roja y azul parpadeando

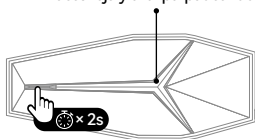

Únase a 2 o N miembros.

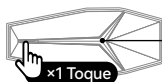

Luz azul oscuro encendida



Forma un equipo

Modo de grupo

Después de Group mesh, puedes elegir el modo de grupo o el modo libre.

Control por voz



Hi Max, group mode

También puedes:

Operación clave

Luz azul oscuro encendida

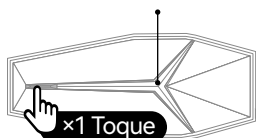

Modo libre

Control por voz



Hi Max, free mode

También puedes:

Operación clave

Luz azul oscuro encendida

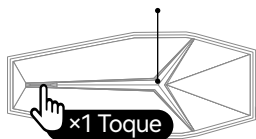

Modo Líder Modo Líder

en el Modo Equipo, el líder y los 3 pilotos del primer y último coche pueden crear un "subgrupo" para hablar entre ellos

Ajustes del Modo Líder

Líder de grupo (Durante el proceso de formación del grupo, el ciclista que pulse el "botón del intercomunicador" para confirmar la finalización del grupo se convertirá automáticamente en el líder del grupo).

Pasos 1

El propietario del grupo hace clic aquí para iniciar la configuración

Tamaño del chat de grupo > 3

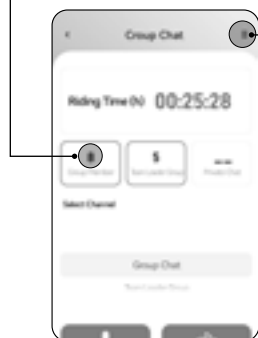

Pasos 2

Haz clic aquí para iniciar la configuración

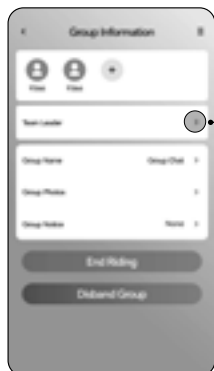

Pasos 3

Ve a esta página y haz clic en "+" para iniciar la configuración



Chat privado

cualquier piloto, chat privado 1v1 en modo grupo

Configuración del chat privado (cualquier piloto)

Pasos 1

Haz clic aquí para iniciar la configuración



Pasos 2

Haz clic en tu avatar para seleccionar los miembros del chat privado

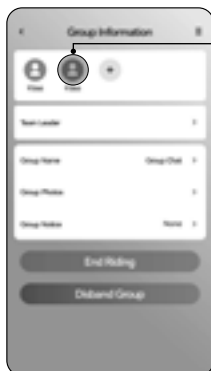

Commutación del intercomunicador en diferentes modos

Operación clave

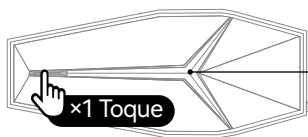

Luz azul oscuro encendida

Passez entre le Mode Leader et le Mode Privé en appuyant et en maintenant enfoncé pendant 2 secondes.

Interrupteur de Contrôle pour Base Magnétique.

Consejos de operación

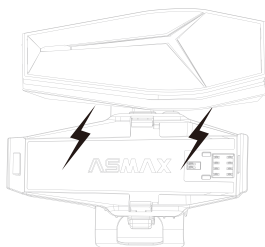
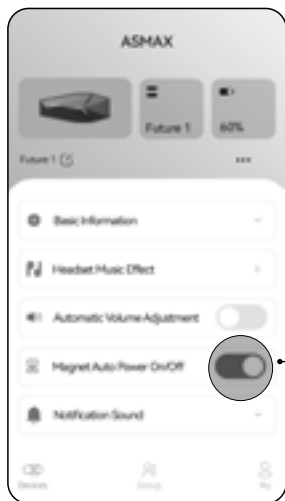

Activez l'interrupteur de contrôle dans l'application.

S'allume automatiquement lorsqu'il est attaché à la base magnétique.

Modo Universal

Operación clave

Entrar en emparejamiento

1

Luces roja y azul
parpadeando

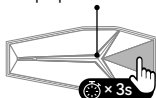

2

Luces roja y verde
parpadeando

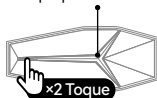

Intercomunicador de otra marca

3

sigue sus instrucciones

Ingrese al modo
de emparejamiento

Iniciar intercomunicador

4

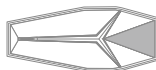

Finalizar intercomunicador

Control por voz



Hi Max, end intercom

También puedes:

Operación clave

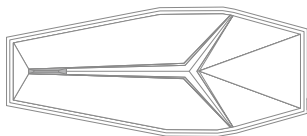
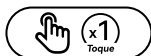

Restablecimiento de fábrica

Operación clave

Luz roja encendida

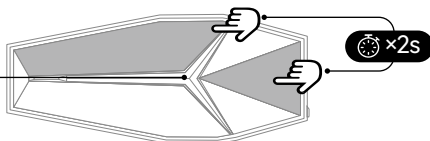

Operación Rápida

ASMAX tiene dos formas de operación: comandos de voz inteligentes y teclas. Puedes elegir libremente según su preferencia.

Cuando el dispositivo principal está conectado a la aplicación oficial de ASMAX y el teléfono está conectado a Internet, el dispositivo puede realizar diversas operaciones de interacción inteligente por voz, como navegación de rutas, enviar mensajes de WeChat, hacer y recibir llamadas, reproducir música, entre otras.

En el estado sin conexión a internet, el dispositivo principal puede realizar operaciones de voz a través de comandos de voz locales fuera de línea.

Palabra de Activación **Hi Max**

Función

Control por voz



Operación clave

ENCENDER / APAGAR



VOLUMEN +

Hi max, volume up



VOLUMEN -

Hi max, volume down



EMPAREJAR
TELÉFONO/GPS

Hi max, phone pairing



RESPONDER A
UNA LLAMADA

Hi max, answer the phone



Cualquier
botón

FINALIZAR
UNA LLAMADA

Hi max, hang up



RECHAZAR
UNA LLAMADA



REPRODUCIR MÚSICA

Hi max, music on



PAUSAR MÚSICA

Hi max, pause music



PISTA ANTERIOR























Hi max, previous track



PISTA SIGUIENTE

Hi max, next track



Función	Control por voz	O	Operación clave
GROUP MESH	<p>Hi max, group mesh</p> <p>↓</p> <p> Únase a 2 o N miembros.</p> <p>↓</p> <p>  (x1)</p> <p>↓</p> <p> Forma un equipo</p>	O	<p>  (x2)</p> <p>↓</p> <p> Únase a 2 o N miembros.</p> <p>↓</p> <p>  (x1)</p> <p>↓</p> <p> Forma un equipo</p>
MODO DE GRUPO	<p>Hi max, group mode</p>		<p>  (x1)</p>
MODO LIBRE	<p>Hi max, free mode</p>		<p>  (x1)</p>
MODO UNIVERSAL			<p>1 Luces roja y azul parpadeando</p> <p>2 Luces roja y verde parpadeando</p> <p> x 3s</p> <p> x 2 Toque</p> <p>3 Seguir sus instrucciones</p> <p>4 Entrar en modo de emparejamiento</p> <p> (x2)</p> <p></p>
FINALIZAR INTERCOMUNICADOR	<p>Hi max, end intercom</p>		<p>  (x1)</p>
RESTABLECIMIENTO DE FÁBRICA			<p>  (x2)</p>

QR コードをスキャンして公式サイトで詳細を見る



www.asmaxconnect.com 

プロフィール

この度は ASMAX ボイスコントロールヘルメット Bluetooth ヘッドセットをお買い上げいただき、誠にありがとうございます。ご使用前に必ず取扱説明書をお読みください。



Bluetooth 5.4



ファームウェアの更新



10 人のライダー
Mesh intercom



IPX7 ぼうすい



チームインターコム



クイックチャージ



他社製デバイスとの接続



ASMAX World App



多言語音声コントロール



マグネット・ドッキング・ステーションから離れると自動的に電源が切れるように設定するアプリ



ENC ノイズキャンセリング

ASMAX WORLD APP

以下の QR コードをスキャンするか、アプリストアから ASMAX WORLD をダウンロードしてインストールしてください。

ダウンロード



ASMAX WORLD App



登録



ユニットを接続する



ユニットを更新する

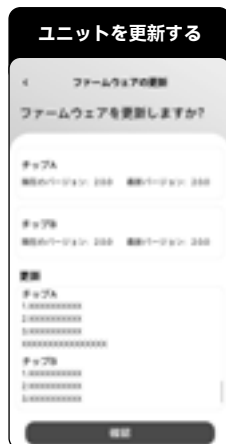

アプリから最新のファームウェアを定期的に更新してください。

パッケージ内容



Future 1 本体



磁気マウント

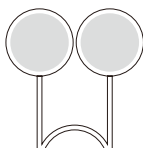

スピーカー



3Mの接着プレート

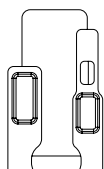

金属クランプ



ブームマイク



ワイヤードマイク

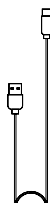

Type-C ケーブル



クリーンパック



両面ベルクロ

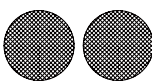

スピーカー用
ステッカー



ワイヤードマイク用
ステッカー



ブームマイク用
ステッカー



マイクスポンジ



マニュアル

インストール

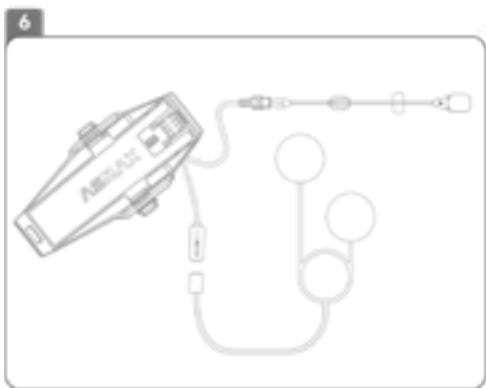

メインユニットを取り外すには、2つのボタンを同時に押すか、1つのボタンだけを押し、メインユニットを逆方向に取り外してください。

本体

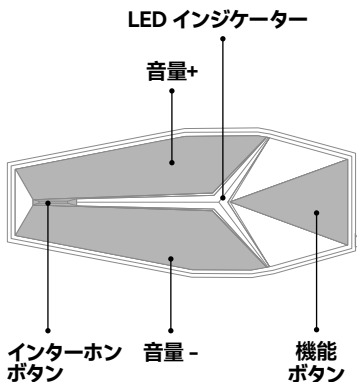

Type-C 充電ポート



注意:

- ヘッドセットは、充電環境によって充電時間が変わる場合がありますが、通常 50 分で完全に充電されます。
- デバイスを充電する際には、出力が 15V を超える充電器を使用しないでください。

基本操作

電源オン / オフ

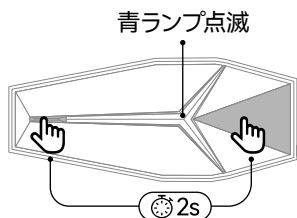

音量を上げる / 下げる

音声操作



はいマックス 音量を上げる



はいマックス 音量を下げる

次の操作も可能:

ボタン操作

音量+

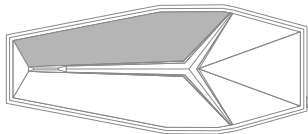

音量-

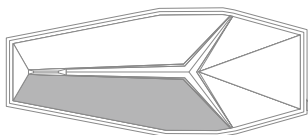

スマホ /GPS のペアリング

音声操作



はいマックス スマホを接続

次の操作も可能:

ボタン操作

1

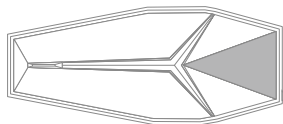
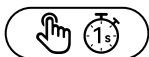

赤青ランプ点滅

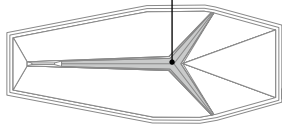

2



3

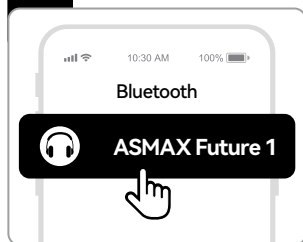

通話

応答 / 終了

音声操作



はいマックス 着信に出る



はいマックス 着信を切る

次の操作も可能:

ボタン操作

着信に出る



x1
1タップ

通話終了



x1
1タップ

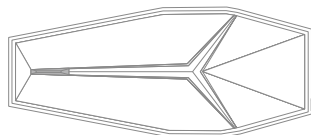
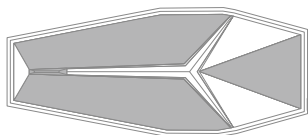

任意のボタン



着信拒否

ボタン操作

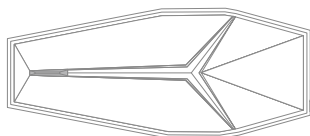

音楽

再生 / 一時停止

音声操作



はいマックス 音楽を再生



はいマックス 音楽を止める

次の操作も可能:

ボタン操作

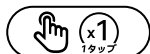
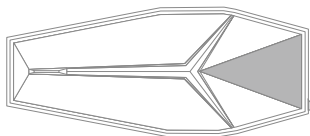

前の曲 / 次の曲

音声操作



はいマックス 前の曲



はいマックス 次の曲

次の操作も可能:

ボタン操作

前の曲



次の曲

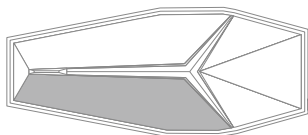
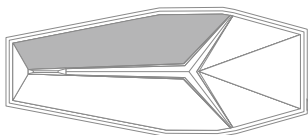

インターコーム

チームをマッチング

音声操作



はいマックス チームをマッチング



2人またはN人のメンバーで参加する

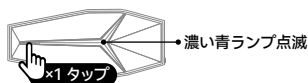

チーム結成

次の操作も可能:

ボタン操作

赤青ランプ点滅

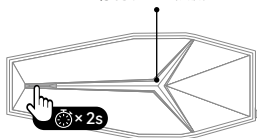

2人またはN人のメンバーで参加する

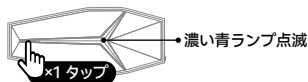

チーム結成

チームモード

チームをマッチングした後に、チームモードまたはフリーモードを選択できます。

音声操作



はいマックス チームモード

次の操作も可能:

ボタン操作

濃い青ランプ点滅

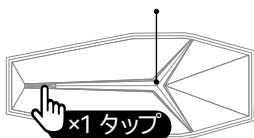

フリーモード

音声操作



はいマックス フリーモード

次の操作も可能:

ボタン操作

濃い青ランプ点滅

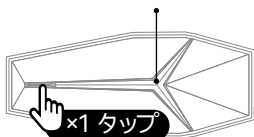

リーダーモード リーダーモード

チームモードでは、リーダーと先頭車と最後尾車の3人が「サブ」グループを設定して会話することができる

リーダーモード設定

グループリーダー(グループ編成中、「インカムボタン」を押してグループ成立を確認したライダーが自動的にグループリーダーになります。)

ステップ1

グループオーナーはここをクリックしてセットアップを開始します。

→ グループチャットのサイズ ≥ 3

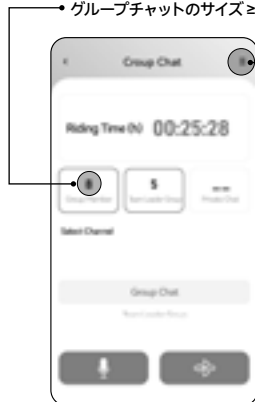

ステップ2

ここをクリックして設定を開始する

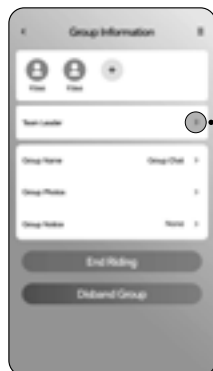

ステップ 3

このページに移動し、“+”をクリックして設定を開始します。

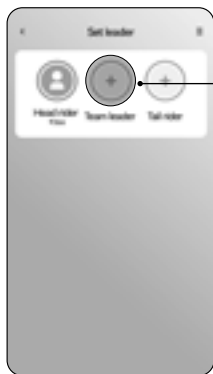

プライベートチャット

どのライダーもチームモードで1対1のプライベートチャットができる

プライベートチャットの設定 (ライダーを問わず)

ステップ 1

ここをクリックして設定を開始する

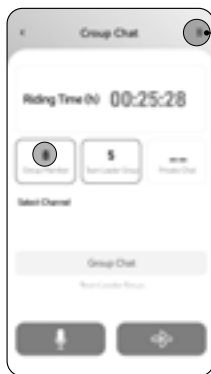

ステップ 2

自分のアバターをクリックし、プライベートチャットメンバーを選択します。

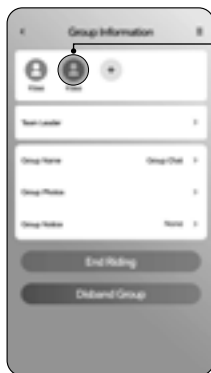

異なるモードでのインカム切り替え

ボタン操作

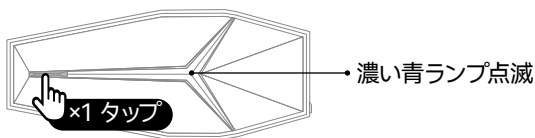

リーダーモードとプライベートモードの切り替え、2秒間長押し

マグネット式のエアマウントで電源のオン・オフを制御します。

操作のヒント

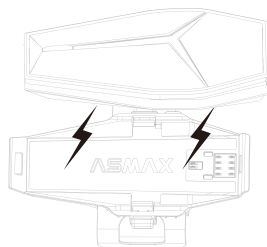
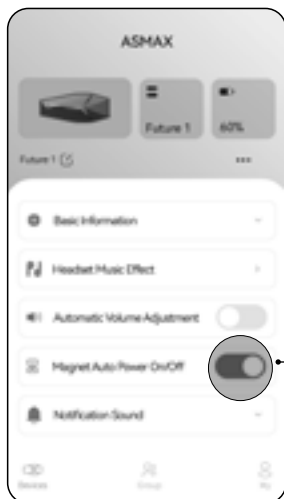

アプリで制御スイッチをオンにする必要があります。

マウントに吸引すると、自動的に電源がオンにして、マウントから離れると、自動的にオフにします。

ユニバーサルモード

ボタン操作

ペアリングに入る

①

赤青ランプ点滅

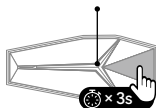

②

赤緑ランプ点滅



他のブランドのインカム

③

彼らの指示に従って

ペアリングモードに入る

インターホンを開始する

④

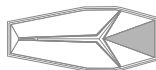

インターホンを終える

音声操作



はいマックス インターホンを終える

次の操作も可能:

ボタン操作

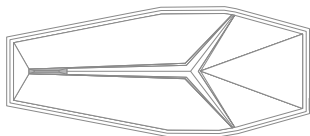
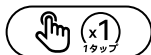

工場出荷時設定にリセットする

ボタン操作

赤ランプ点滅

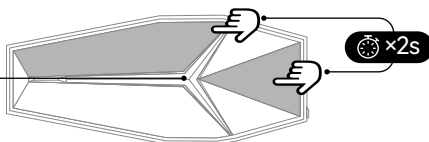

クイック操作

ASMAXには、スマート音声コマンドとボタン操作の2つの方法があります。お好みに応じて自由に選択できます。

本品はASMAX公式アプリと接続完了およびスマホはネットワークに接続された場合で、本品はナビゲーション、メッセージの送信、通話の受信、音楽の再生などのスマート音声インタラクションを実行できます。

ネットワークに接続されていない場合、本体は以下のオフライン音声コマンドを使用して音声操作を行うことができます。

ウェイクワード **はいマックス**

機能

音声操作

または

ボタン操作

電源オン/オフ



音量+

はいマックス 音量を上げる



音量-

はいマックス 音量を下げる



スマホを接続する

はいマックス スマホを接続



着信に出る

はいマックス 着信に出る



任意のボタン

通話終了

はいマックス 着信を切る



着信拒否



音楽を再生する

はいマックス 音楽を再生



音楽の一時停止

はいマックス 音楽を止める



前の曲

はいマックス 前の曲



次の曲

はいマックス 次の曲



機能

音声操作

または

ボタン操作

チームをマッチングする

はいマックス チームをマッチング



2人またはN人のメンバーで参加する

2人またはN人のメンバーで参加する



チーム結成

チーム結成

チームモード

はいマックス チームモード



フリーモード

はいマックス フリーモード



ユニバーサルモード

はいマックス デバイスを接続して



インターホンを終える

はいマックス インターホンを終える



工場出荷時設定にリセットする



扫描二维码,在官网了解更多信息



www.asmaxconnect.com 

简介

再次感谢您选择 ASMAX 语音控制头盔蓝牙耳机。在使用设备前请阅读操作手册。



蓝牙 5.4



OTA 无线更新设备



10 名骑手
Mesh 机制对讲



IPX7 防水



团队对讲



快充



桥接配对
与其他品牌耳机连接



ASMAX World App



多语言的语音控制



App 设置离座待机
离开磁吸底座自动待机



ENC 降噪

ASMAX WORLD APP

您可以扫描右侧二维码或从应用商城下载并安装 ASMAX WORLD。
ASMAX 设备更多功能设置等您来解锁。

下载



ASMAX WORLD App

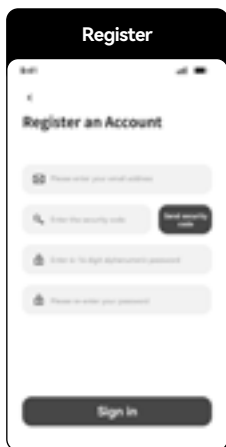

更新到最新的软件版本，
确保最好的体验。

包装清单



Future 1 主机



磁吸底座

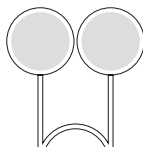

喇叭单元



3M胶背夹

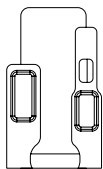

金属夹



硬管麦克风



软管麦克风

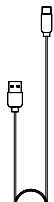

Type-C 快充线



清洁包



双面魔术贴

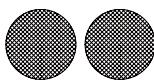

喇叭魔术贴



软麦魔术贴



硬麦魔术贴



硬麦防风棉



简易说明书

安装

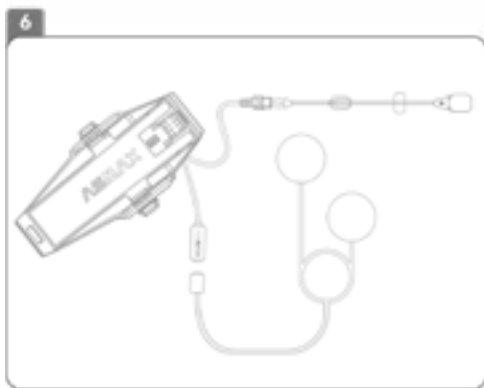

拆卸主机时，请同时按下两个按钮，或者只按一个按钮，但反方向拆卸主机。

主机介绍

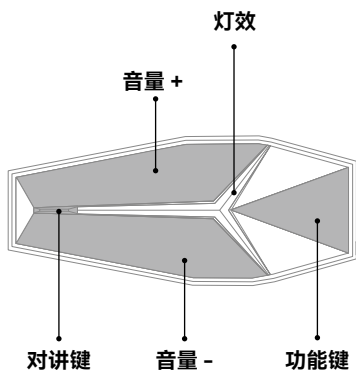

Type-C 充电口

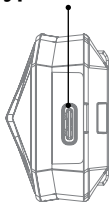

注意:

- 主机可在 50 分钟内充满电(充电时间会受充电环境影响)。
- 请不要使用输出电流超过 15V 的充电器给主机充电。

基本操作

开 / 关机

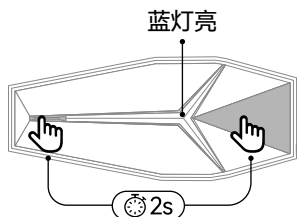

增大 / 减小音量

语音词条



Hi Max, 增大音量



Hi Max, 减小音量

您也可以,

按键操作

音量 +



x1
Tap

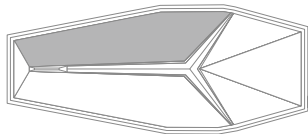

音量 -



x1
Tap

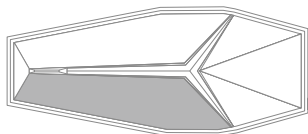

手机 /GPS 配对

语音词条



Hi Max, 手机配对

您也可以,

按键操作

1

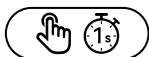

红蓝灯闪烁

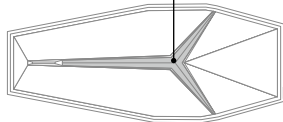
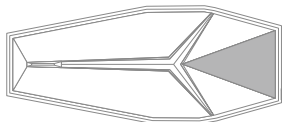

2



3

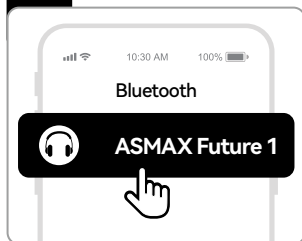

电话

接 / 挂电话

语音词条



Hi Max, 接听电话



Hi Max, 挂断电话

您也可以,

按键操作

接电话

x1
Tap

挂电话

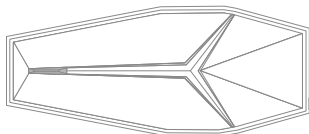
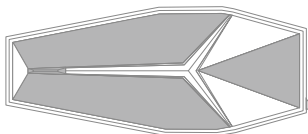
x1
Tap

任意键



拒接电话

按键操作

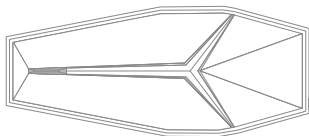
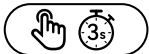

音乐

播放 / 暂停音乐

语音词条



Hi Max, 播放音乐



Hi Max, 暂停播放

您也可以,

按键操作

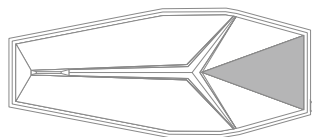

上 / 下一首

语音词条



Hi Max, 上一首



Hi Max, 下一首

您也可以,

按键操作

上一首



下一首

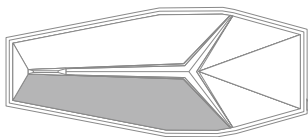
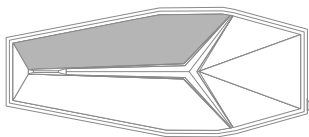

对讲

团队组网

语音词条



Hi Max, 团队组网



播报: 2...N 人

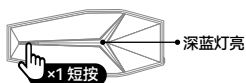

组网成功

您也可以,

按键操作

红蓝灯闪烁

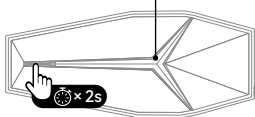

播报: 2...N 人

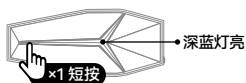

组网成功

团队模式

主机在成功完成团队组网后, 可选择团队模式和自由模式。

语音词条



Hi Max, 团队模式

您也可以,

按键操作

深蓝灯亮

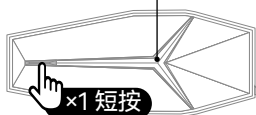

自由模式

语音词条



Hi Max, 自由模式

您也可以,

按键操作

深蓝灯亮

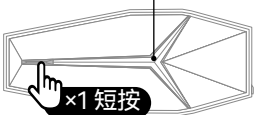

领队模式

团队模式中, 领队和头车, 尾车 3 名骑手可设置“子”小组进行通话

领队模式设置

群主(在组网过程中, 按下“对讲键”确定组队完成的骑手, 自动成为群主)

步骤 1

群主点击图标, 开始设置

群聊人数 ≥ 3

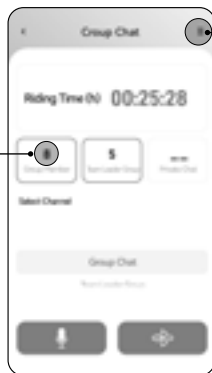

步骤 2

点击此处, 开始设置

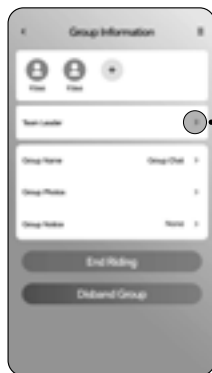

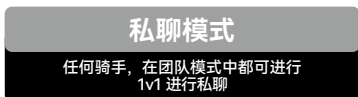
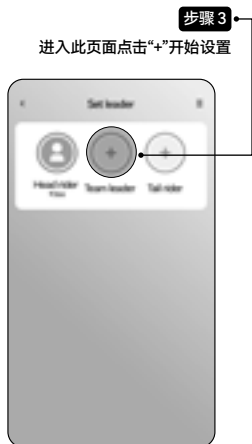

私聊设置 (任何骑手)

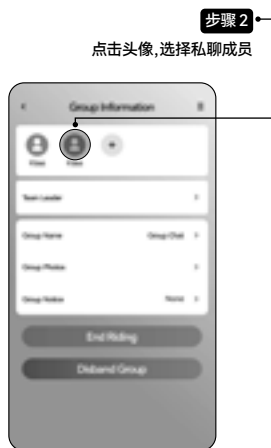
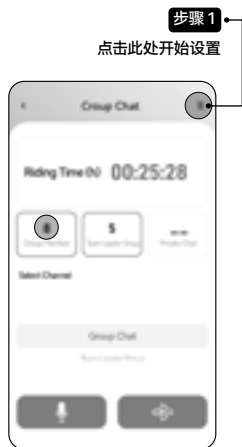

不同模式下的切换

按键操作

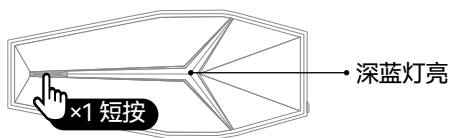

注意 领队模式和私密模式切换长按 2s

磁吸底座控制开关机

操作提示

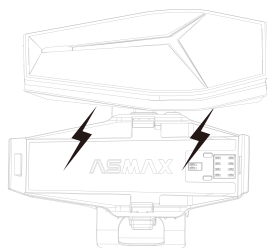
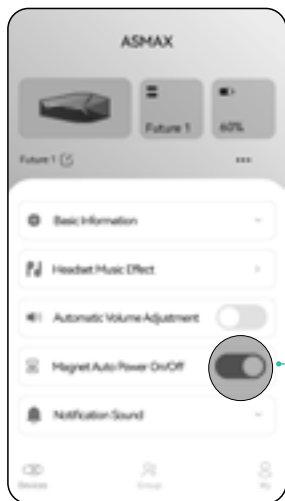

注意: 需要在手机 APP 设备页面打开【高座待机】开关

放上磁吸就自动开机，
脱离就自动关机

桥接

按键操作

进入桥接配对状态

①

红蓝灯闪烁

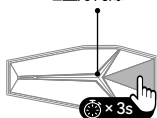

②

红绿灯闪烁

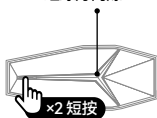

其他品牌产品

③

按其说明书操作

进入
配对状态

开启对讲

④

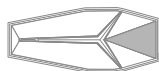

结束对讲

语音词条



Hi Max, 结束对讲

您也可以,

按键操作

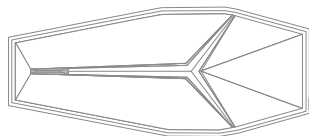

恢复出厂设置

按键操作

红灯亮

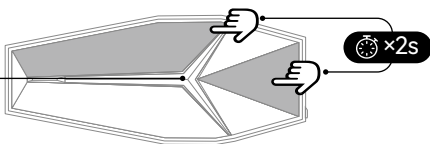

快速操作汇总

ASMAX 有智能语音命令和按键两种操作方式，您可以根据自己的习惯自由选择。

在主机连接 ASMAX WORLD APP 且手机联网状态下，主机可执行路线导航、发送消息、接打电话、播放音乐等等智能语音交互操作。

在未连接网络状态下，主机可通过本地离线语音指令进行语音操作。

唤醒词 **Hi Max**

功能

语音词条

或

按键操作

开关机



增大音量

Hi Max, 增大音量



减小音量

Hi Max, 减小音量



手机 /GPS 配对

Hi Max, 手机配对



接听电话

Hi Max, 接听电话



任意键

挂断电话

Hi Max, 挂断电话



拒接电话



播放音乐

Hi Max, 播放音乐



暂停播放

Hi Max, 暂停播放



上一首

Hi Max, 上一首



下一首

Hi Max, 下一首



功能

语音词条

或

按键操作

团队组网

Hi Max, 团队组网

 播报: 2...N人

 组网成功

 播报: 2...N人

 组网成功

团队模式

Hi Max, 团队模式



自由模式

Hi Max, 自由模式



桥接

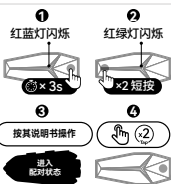

结束对讲

Hi Max, 结束对讲



恢复出厂设置



掃描二維碼,在官網瞭解更多資訊



www.asmaxconnect.com 

簡介

再次感謝您選擇 ASMAX 語音控制頭盔藍芽耳機。在使用設備前請閱讀操作手冊。



藍牙版本 5.4



OTA 無線更新設備



10 名騎士
Mesh 機制對講



IPX7 防水



團隊實時對講



快充



與其他品牌設備連接



ASMAX World App



多語言的語音控制



App 設置離座待機, 離開
磁吸底座自動待機



ENC 降噪

ASMAX WORLD APP

您可以掃描下方二維碼或從應用商城下載並安裝 ASMAX WORLD。
ASMAX 設備更多功能設置等您來解鎖。

下載



ASMAX WORLD App

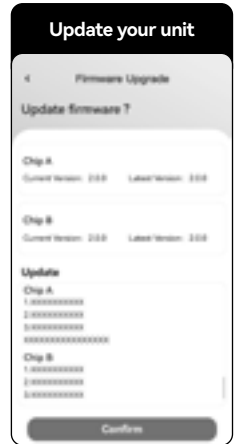
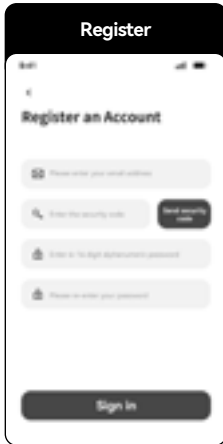

更新到最新的軟件版本,確保最好的體驗。

包裝清單



Future 1 主機



磁吸底座

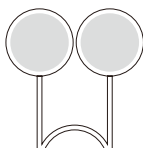

喇叭单元



3M膠背夾

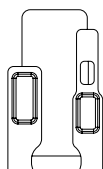

金屬夾



硬管麥克風



軟管麥克風

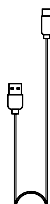

Type-C 快充線



清潔包



雙面魔術貼

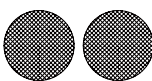

喇叭魔術貼



軟麥魔術貼



硬麥魔術貼



硬麥防風棉



簡易說明書

安裝

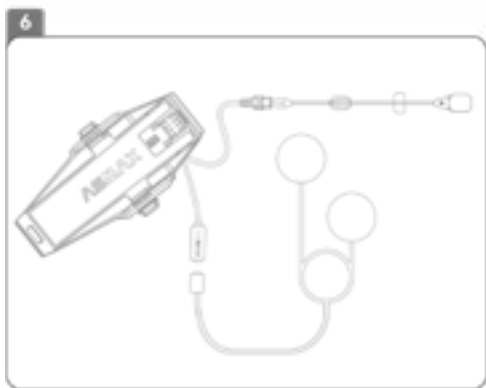

拆卸主機時，請同時按下兩個按鈕，或者只按一個按鈕，但反方向拆卸主機。

主機介紹

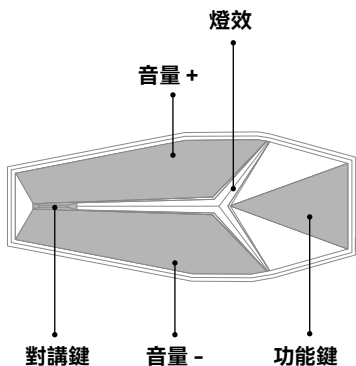

Type-C 充電口



註意:

- 主機可在 50 分鐘內充滿電(充電時間會受充電環境影響)。
- 請不要使用輸出電流超過 15V 的充電器給主機充電。

基本操作

開 / 關機

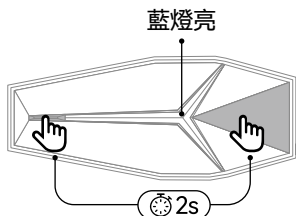

增大 / 減小音量

語音詞條



Hi Max, 增大音量



Hi Max, 減小音量

您也可以,

按鍵操作

音量 +



x1 Tap

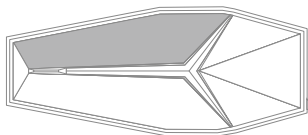

音量 -



x1 Tap

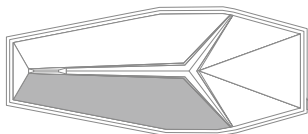

手機 /GPS 配對

語音詞條



Hi Max, 手機配對

您也可以,

按鍵操作

1

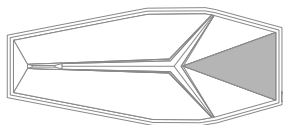
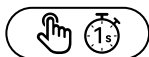

紅藍燈閃爍

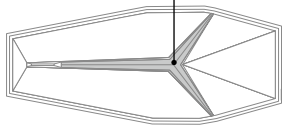

2



3

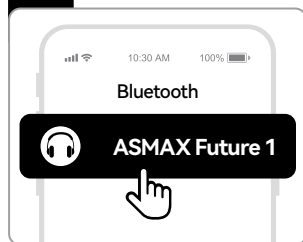

電話

接 / 掛電話

語音詞條



Hi Max, 接聽電話



Hi Max, 掛斷電話

您也可以,

按鍵操作

接電話



x1
Tap

掛電話



x1
Tap

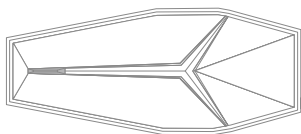
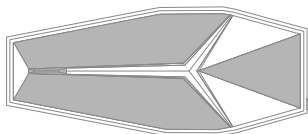

任意鍵



拒接電話

按鍵操作



3s
Tap

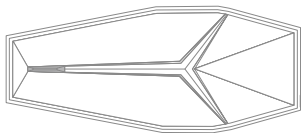

音樂

播放 / 暫停音樂

語音詞條



Hi Max, 播放音樂



Hi Max, 暫停播放

您也可以,

按鍵操作

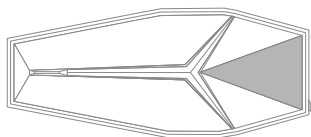

上 / 下一首

語音詞條



Hi Max, 上一首



Hi Max, 下一首

您也可以,

按鍵操作

上一首



下一首

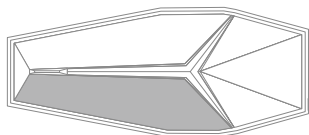
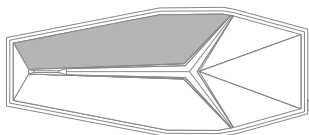

對講

團隊組網

語音詞條



Hi Max, 團隊組網



播報: 2...N 人

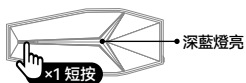

組網成功

您也可以,

按鍵操作

紅藍燈閃爍

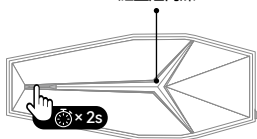

播報: 2...N 人

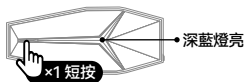

組網成功

團隊模式

主機在成功完成團隊組網後，可選擇
團隊模式和自由模式。

語音詞條

Hi Max, 團隊模式

您也可以,

按鍵操作

深藍燈亮

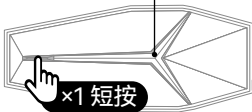
**自由模式****語音詞條**

Hi Max, 自由模式

您也可以,

按鍵操作

深藍燈亮

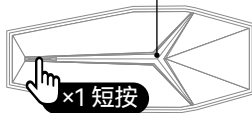
**領隊模式**

團隊模式中，領隊和頭車，尾車 3 名騎手可設置“子”小組進行通話

領隊模式設置

群主(在組網過程中,按下“對講鍵”確定組隊完成的騎手,自動成為群主)

步驟 1

群主點擊此處,開始設置

群聊人數 ≥ 3

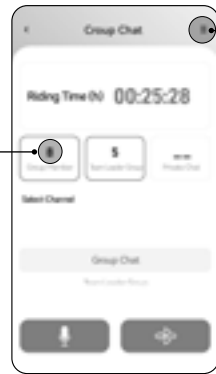
**步驟 2**

點擊此處,開始設置

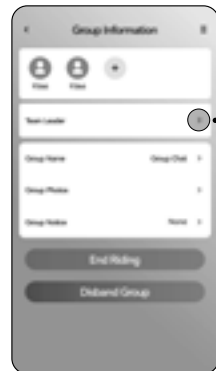

步驟 3

進入此頁面點擊“+”開始設置

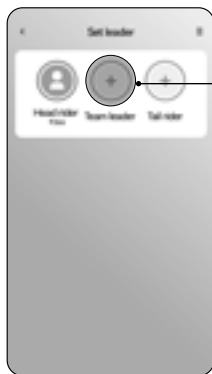

私聊模式

任意騎手，在團隊模式中都可進行 1v1 進行私聊

私聊設置 (任意騎手)

步驟 1

點擊此處，開始設置

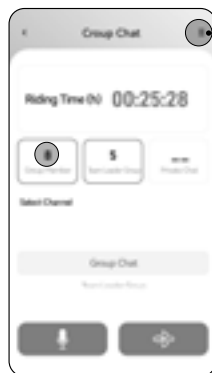

步驟 2

點擊頭像，選擇私聊成員

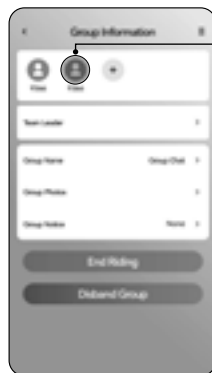

不同模式下的對講切換

按鍵操作

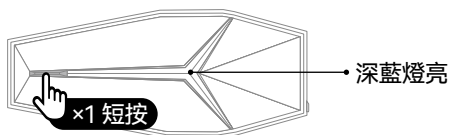

注意 領隊模式和私密模式切換長按 2s

磁吸底座控制開關機

操作提示

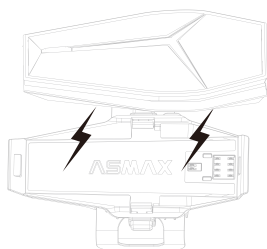
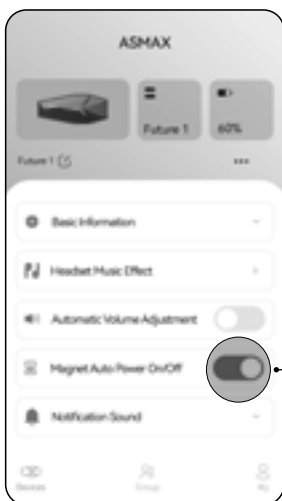

注意: 需要在手機 APP 設備頁面
打開【離座待機】開關

放上磁吸就自動開機，脫離就自動關機

橋接

按鍵操作

進入橋接配對狀態

1

紅藍燈閃爍

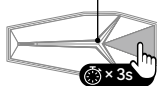

2

紅綠燈閃爍

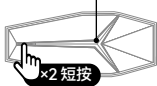

其他品牌產品

3

按其說明書操作

進入
配對狀態

開啟對講

4



結束對講

語音詞條



Hi Max, 結束對講

您也可以,

按鍵操作

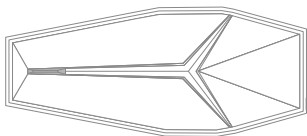
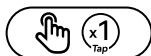

恢復出廠設置

按鍵操作

紅燈亮

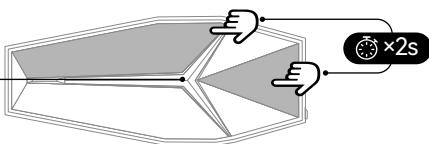

快速操作匯總

ASMAX 有智慧語音命令和按鍵兩種操作管道,您可以根據自己的習慣自由選擇。

在主機連接 ASMAX WORLD APP 且手機聯網狀態下,主機可執行路線導航、發送消息、接打電話、播放音樂等等智慧語音互動操作。

在未連接網絡狀態下,主機可通過本地離線語音指令進行語音操作。

喚醒詞 **Hi Max**

功能

語音詞條

或

按鍵操作

開關機



增大音量

Hi Max, 增大音量



減小音量

Hi Max, 減小音量



手機 /GPS 配對

Hi Max, 手機配對



接聽電話

Hi Max, 接聽電話



任意鍵

掛斷電話

Hi Max, 掛斷電話



拒接電話



播放音樂

Hi Max, 播放音樂



暫停播放

Hi Max, 暫停播放



上一首

























Hi Max, 上一首



下一首

Hi Max, 下一首



功能	語音詞條	或	按鍵操作
團隊組網	<p>Hi Max, 團隊組網</p> <p>↓</p> <p> 播報: 2...N 人</p> <p>↓</p> <p>  <1></p> <p>↓</p> <p> 組網成功</p>	或	<p>  <2></p> <p>↓</p> <p> 播報: 2...N 人</p> <p>↓</p> <p>  <1></p> <p>↓</p> <p> 組網成功</p>
團隊模式	<p>Hi Max, 團隊模式</p>	或	<p>  <1></p>
自由模式	<p>Hi Max, 自由模式</p>	或	<p>  <1></p>
橋接		或	<p>1 紅藍燈閃爍</p> <p>2 紅綠燈閃爍</p> <p>  × 3s</p> <p>  × 2 短按</p> <p>3 按其說明書操作</p> <p> <2></p> <p>4 進入配對狀態</p> <p></p>
結束對講	<p>Hi Max, 結束對講</p>	或	<p>  <1></p>
恢復出廠設置		或	<p>  <2></p>

**FREEDOM
IN INFINITE**

ASMAX

www.asmaxconnect.com 

